



DINO



5888



1

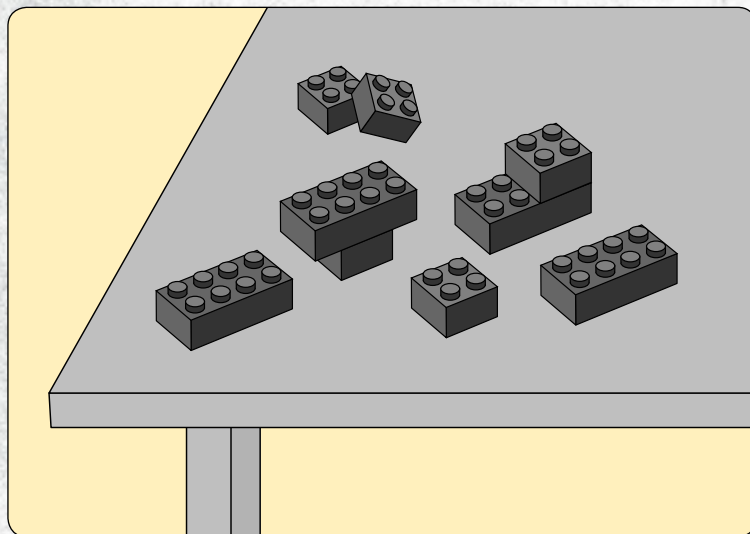
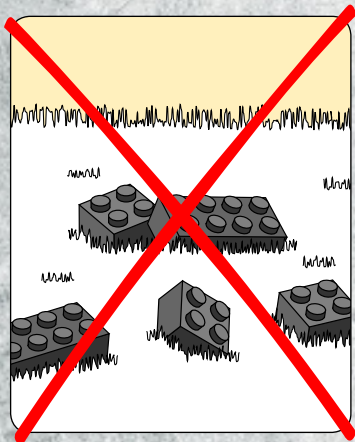

2

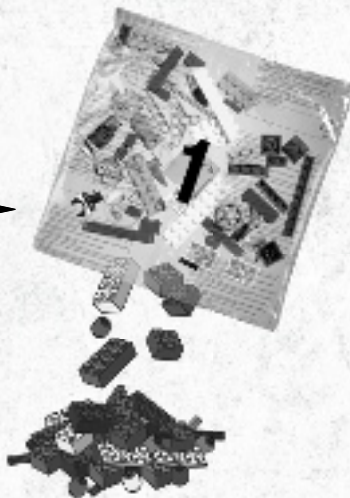

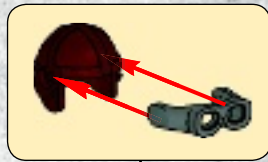
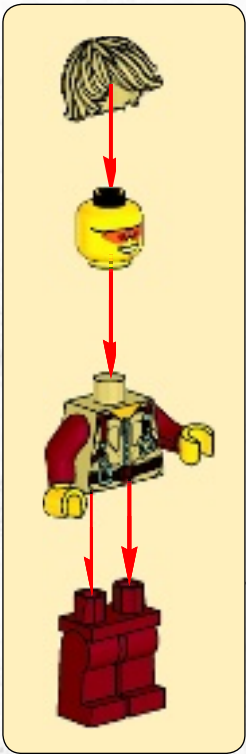
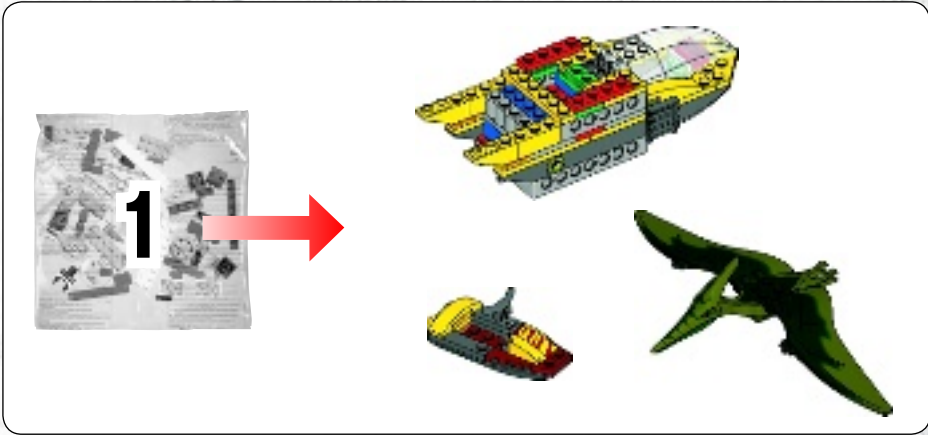

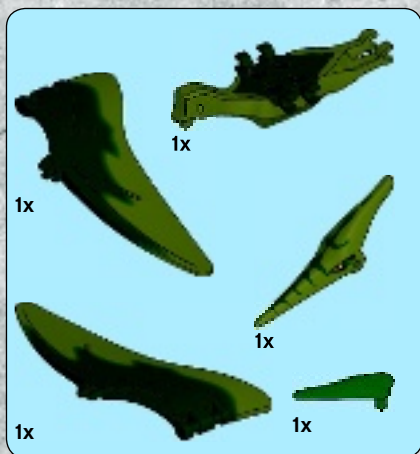

1

1

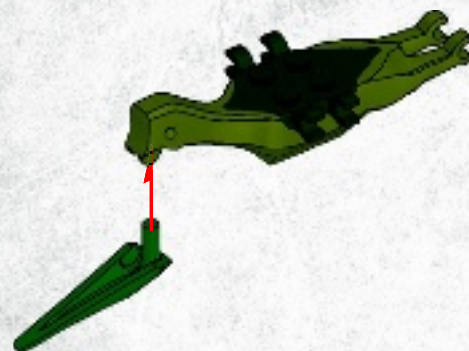

2



3





1

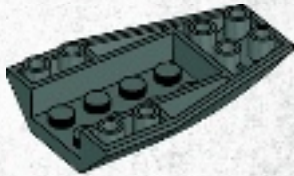

2

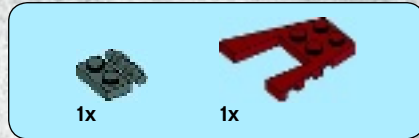

3





1x

4

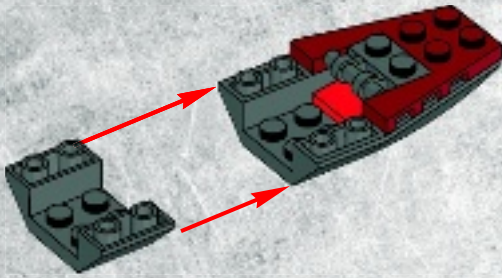

1x

5

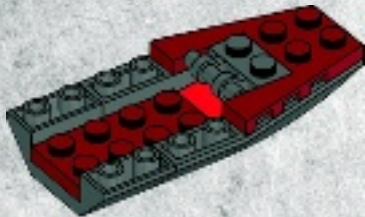

1x



2x

6

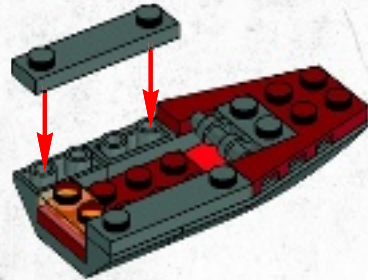

1x



1x

7

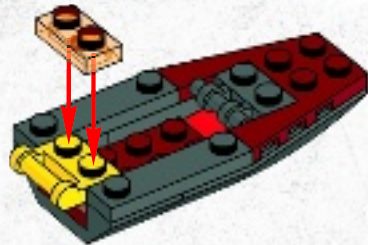



8

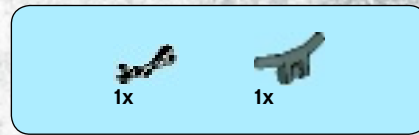

9

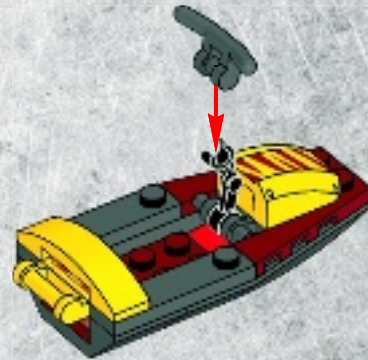



1

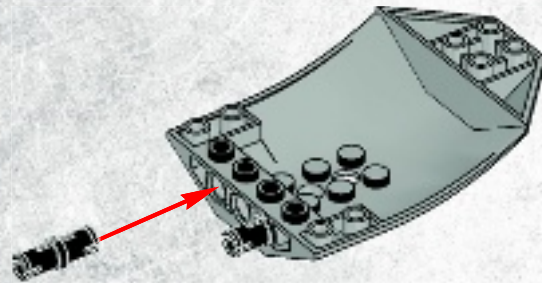

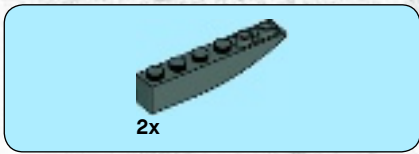

2

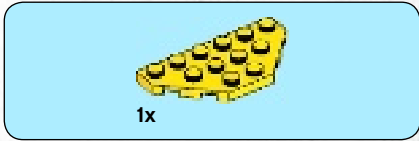
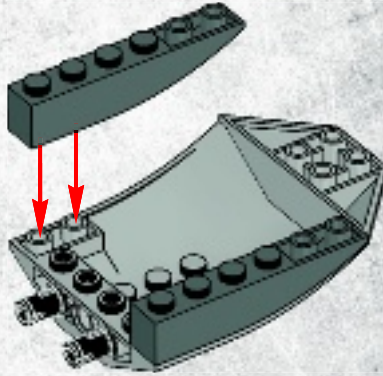

3

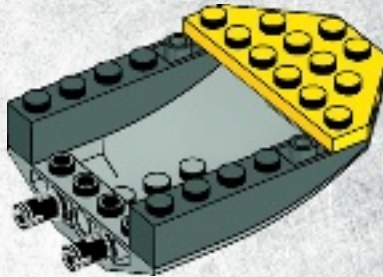



4

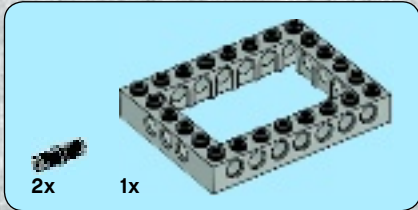
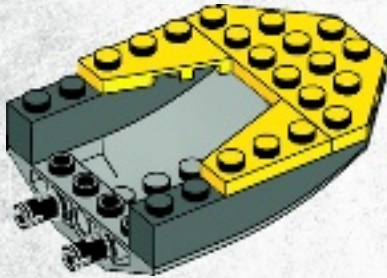

5

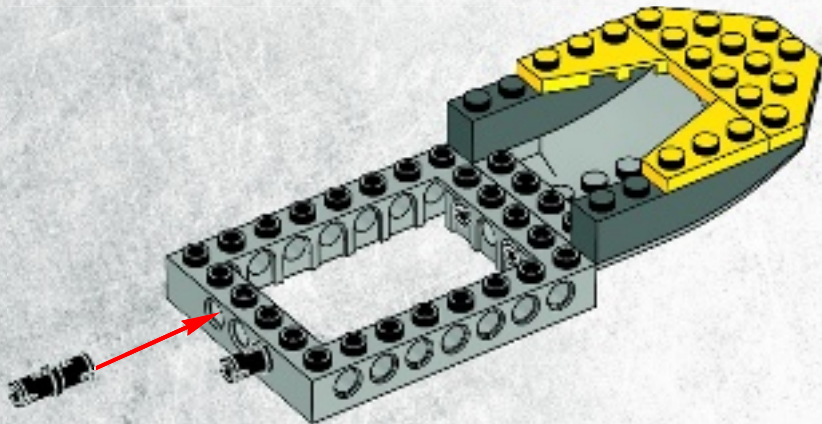



1x

6

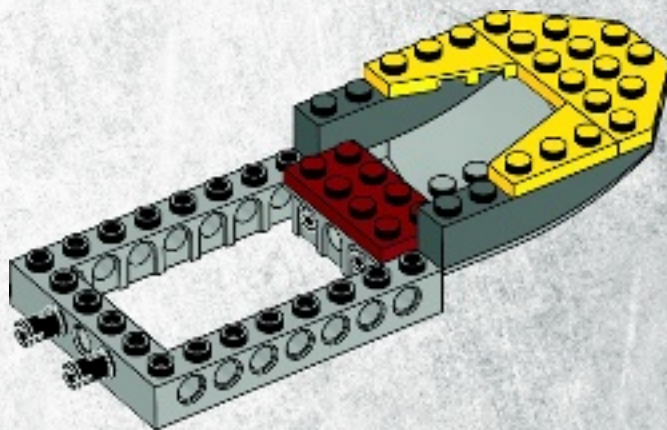

1x

7

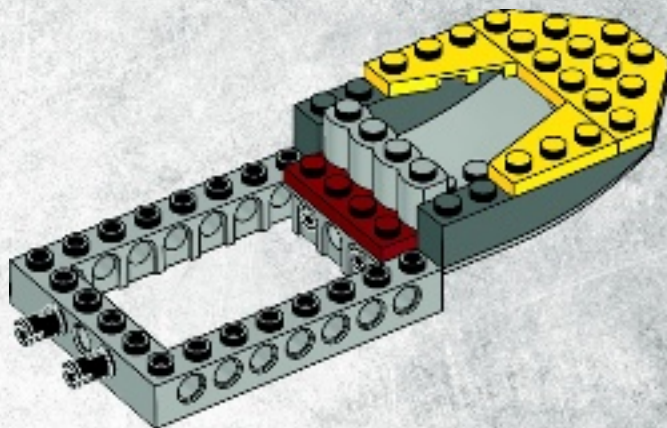

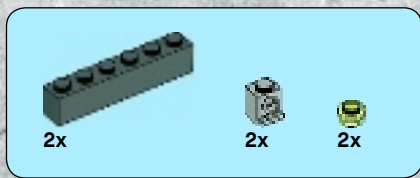

8

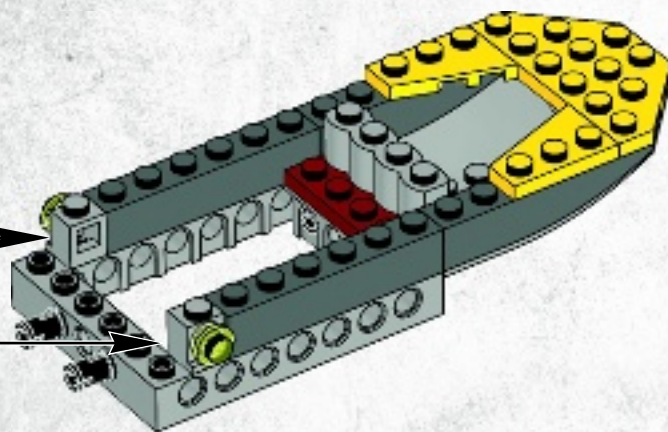
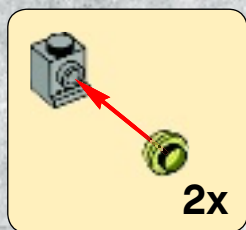



2x

9

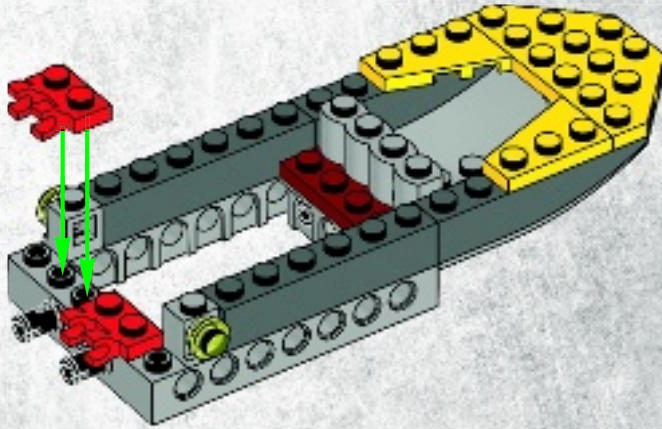

2x

10

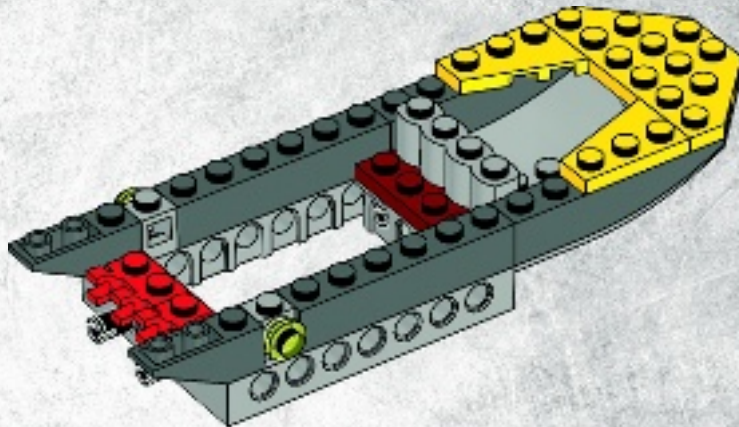



4x

11

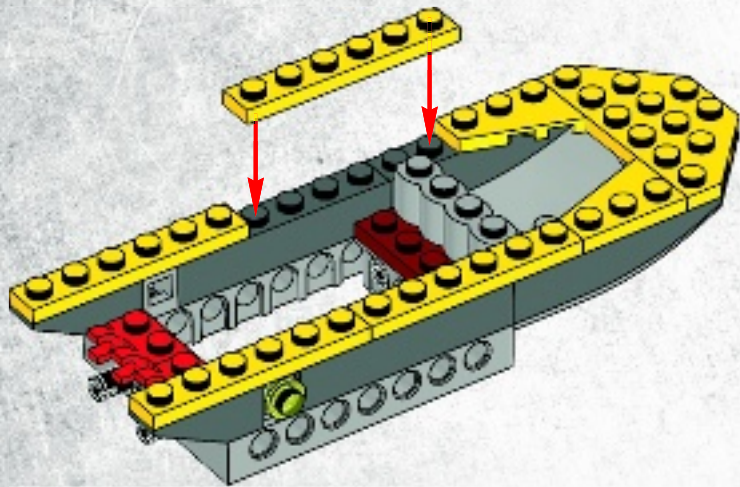

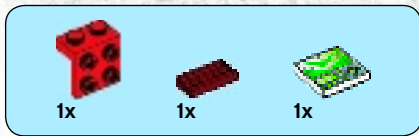

12

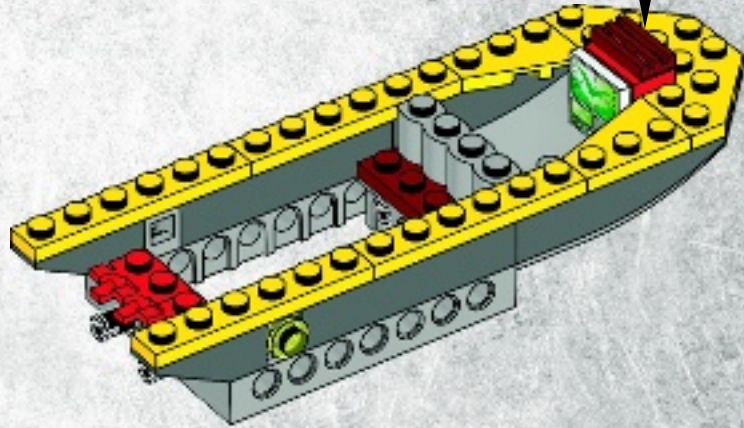
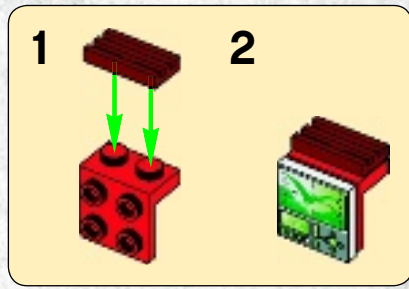

13

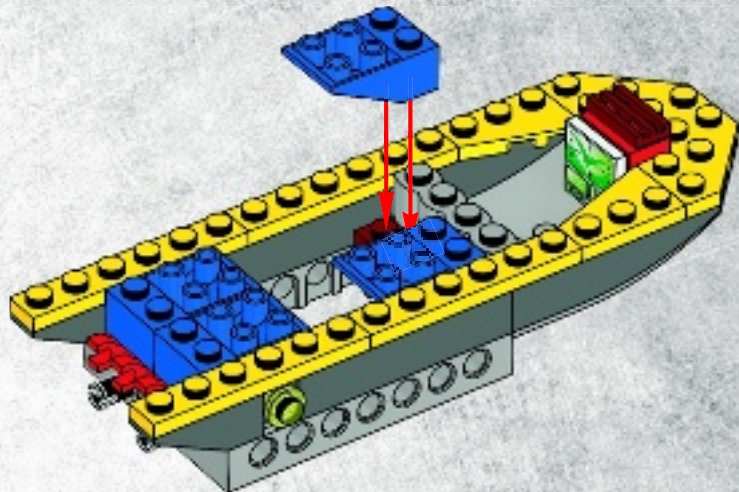



3x



2x

14

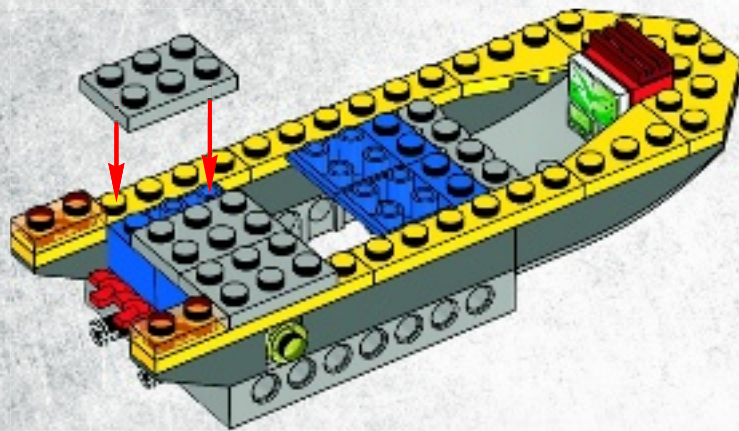

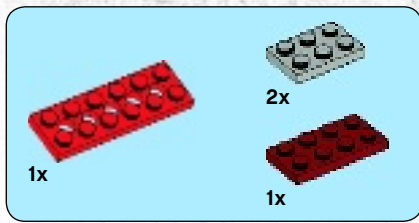

15

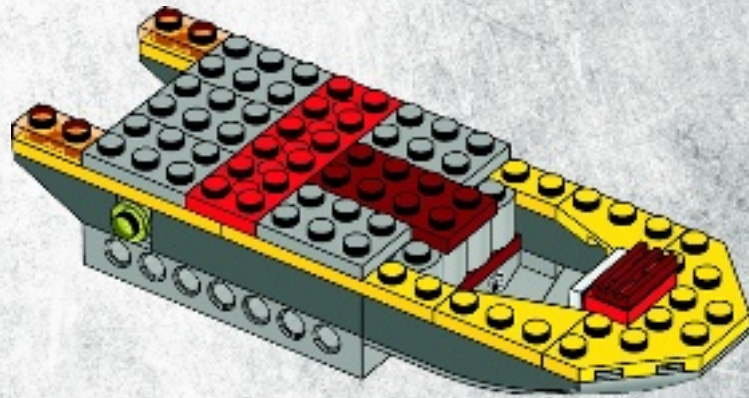

16

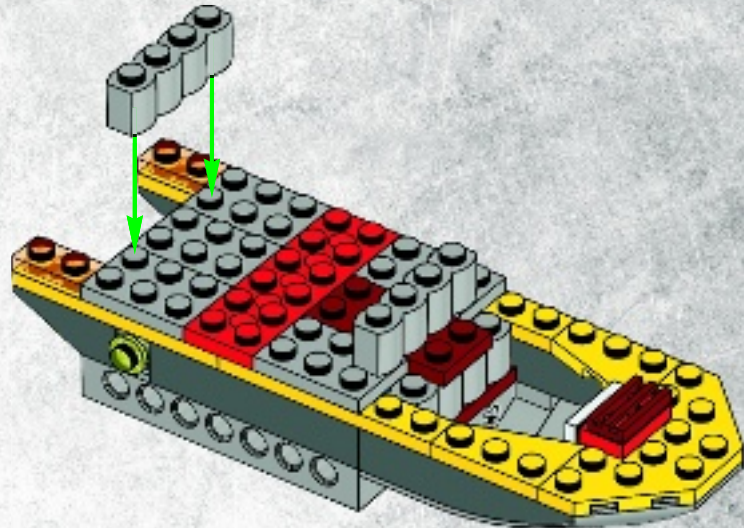



2x

17

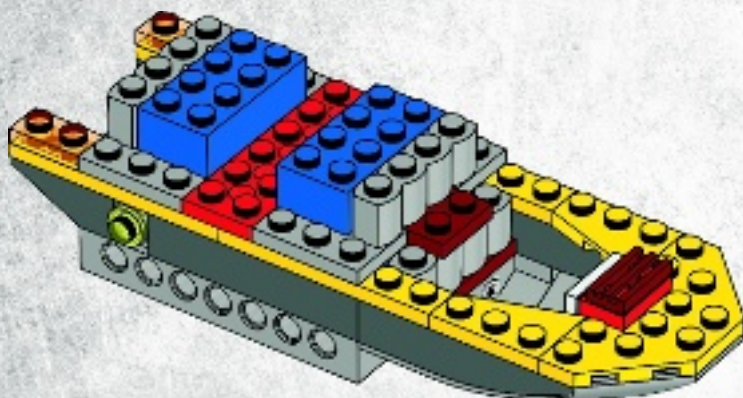



2x

18



2x

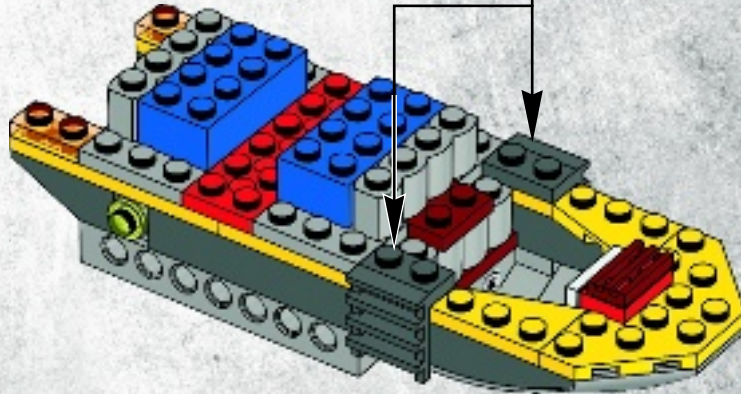

2x



2x

19

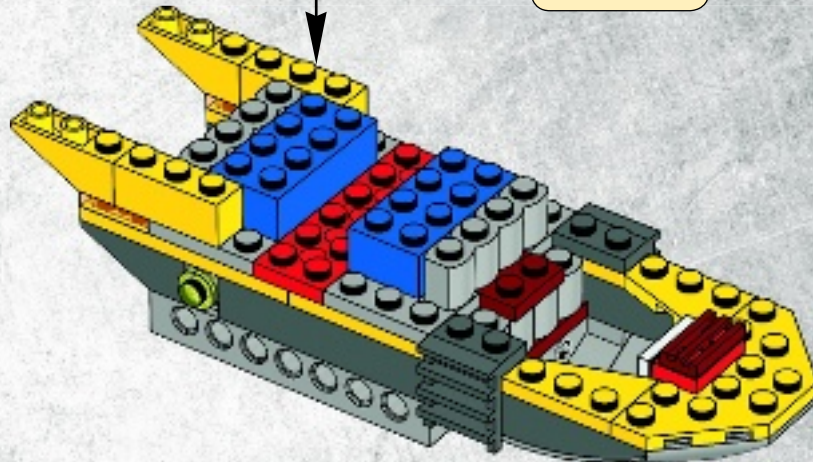
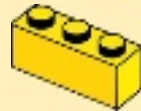

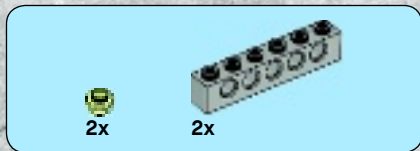

20

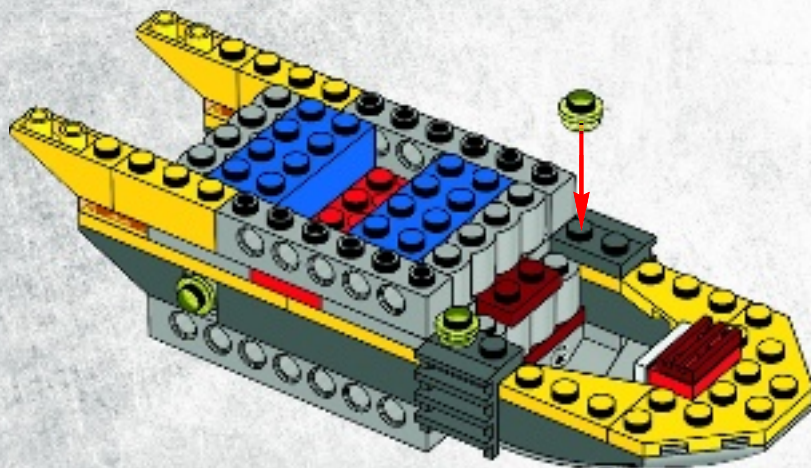

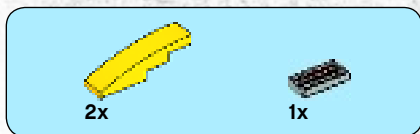

21

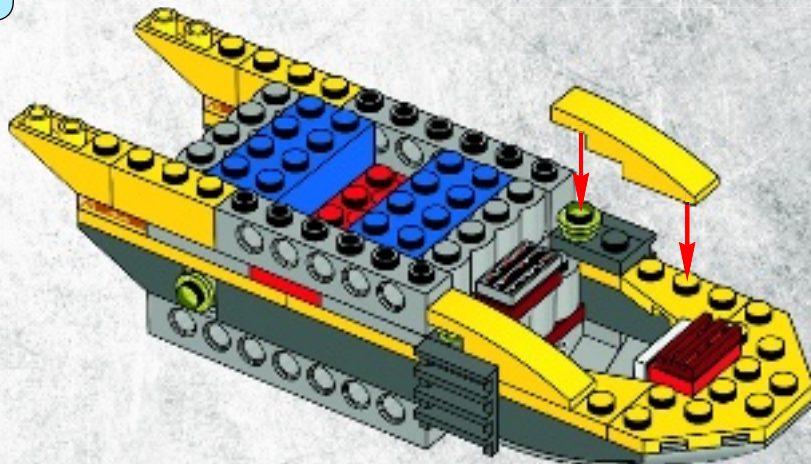

22

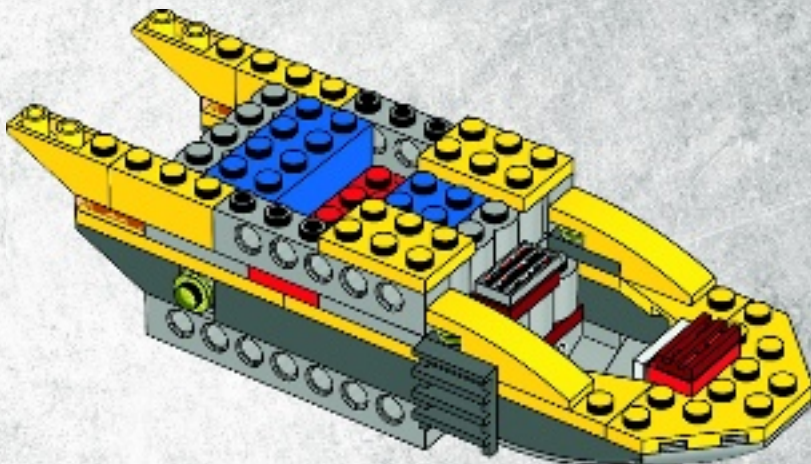



2x

23

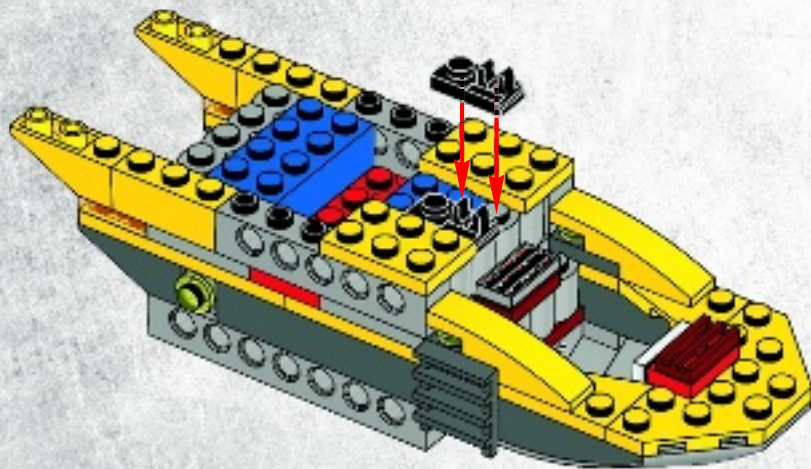

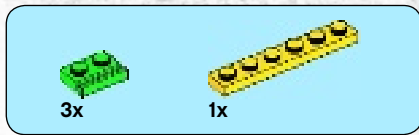

24

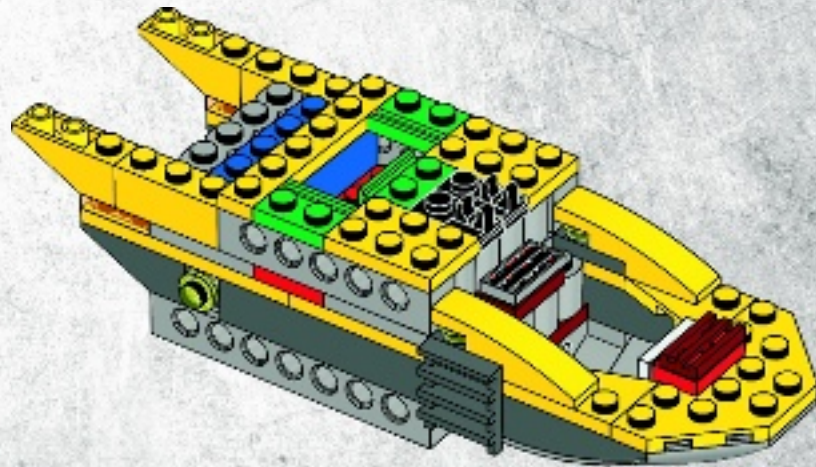

25

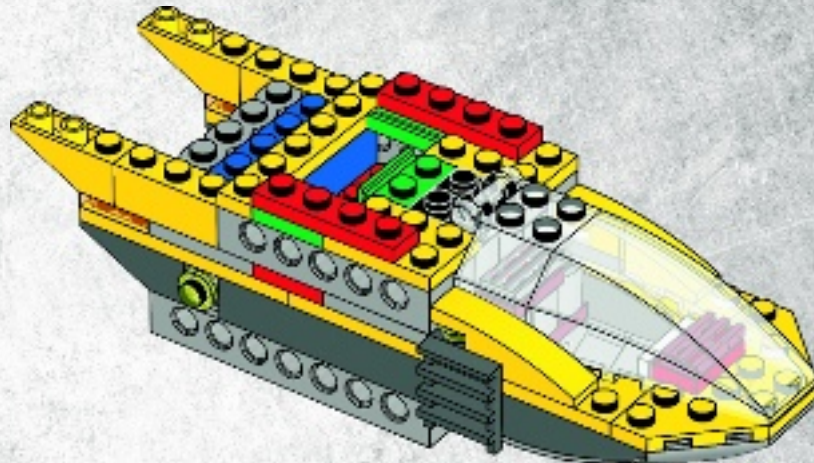



2



1x



1x

26

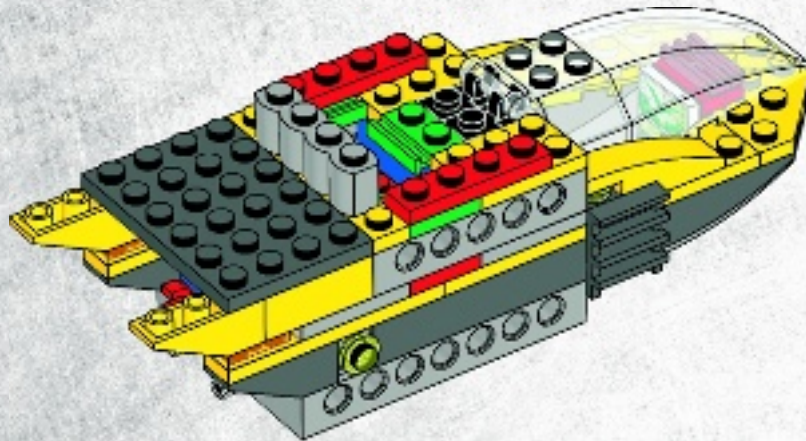



1x

27

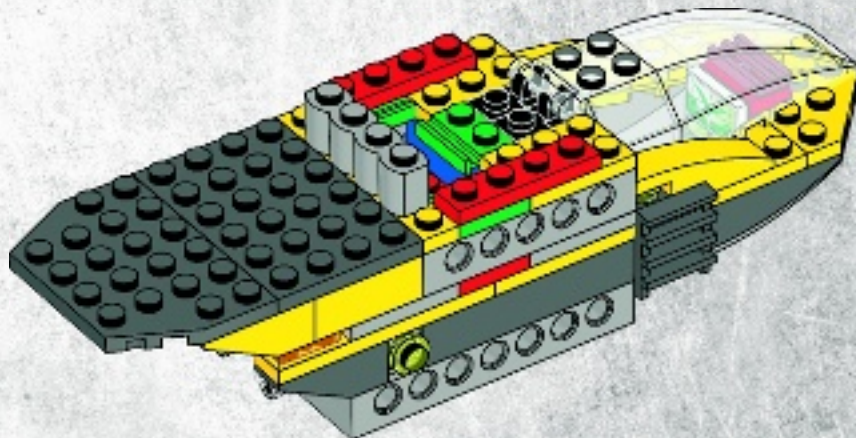

1x



1x

28

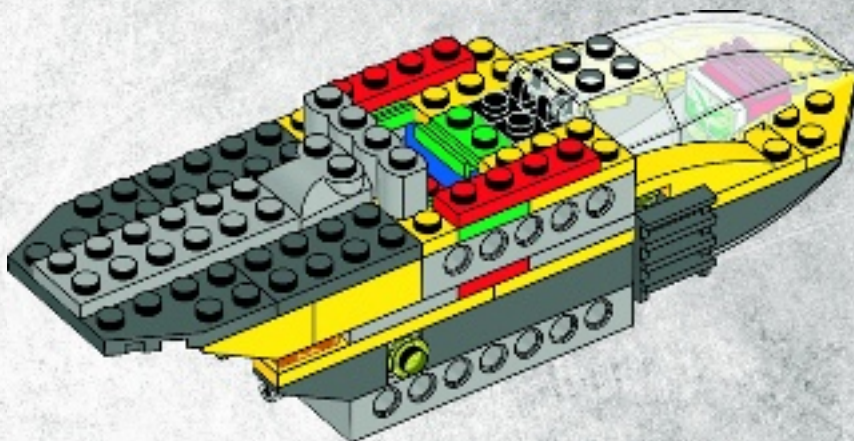

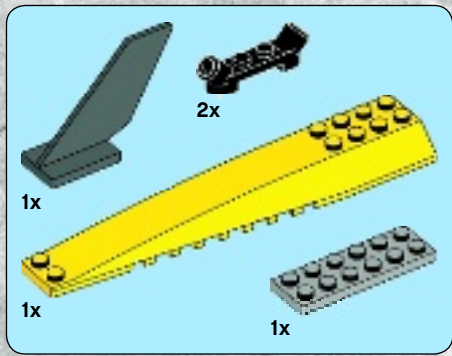

29

1



2

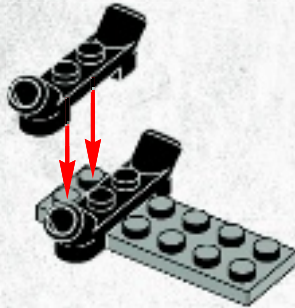

3

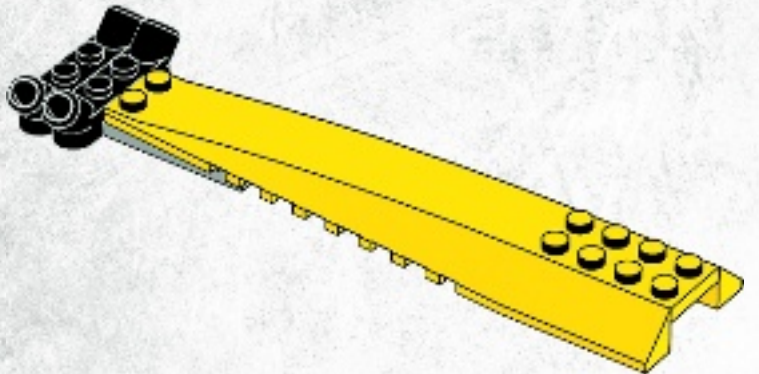

4

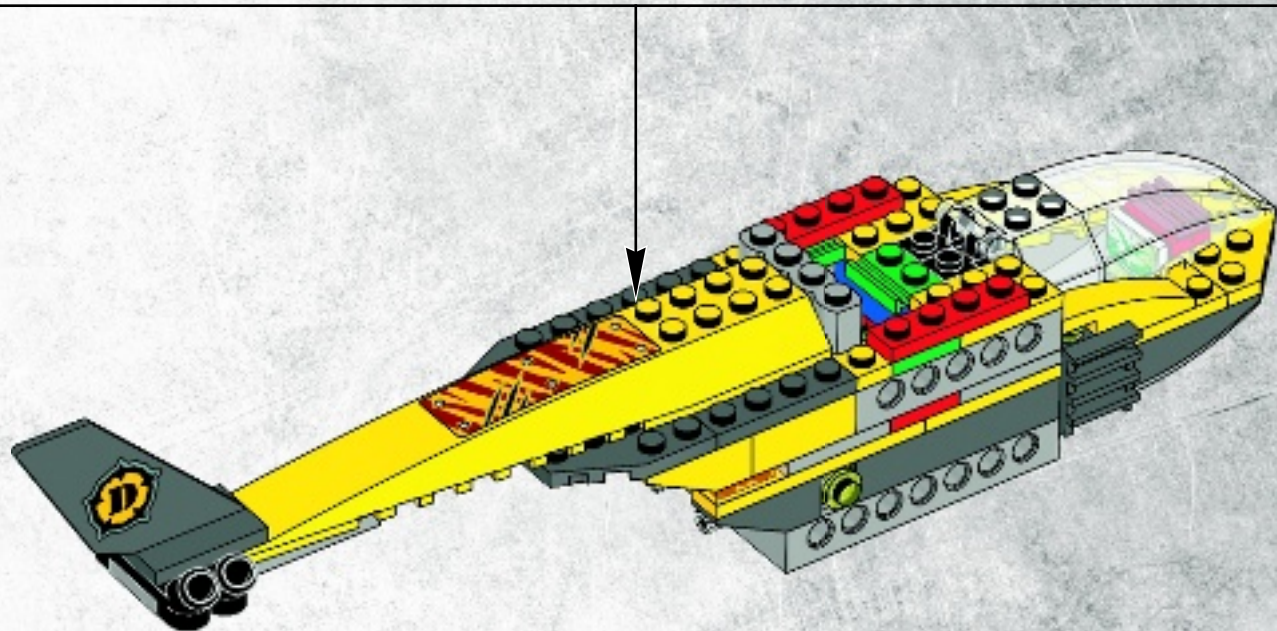
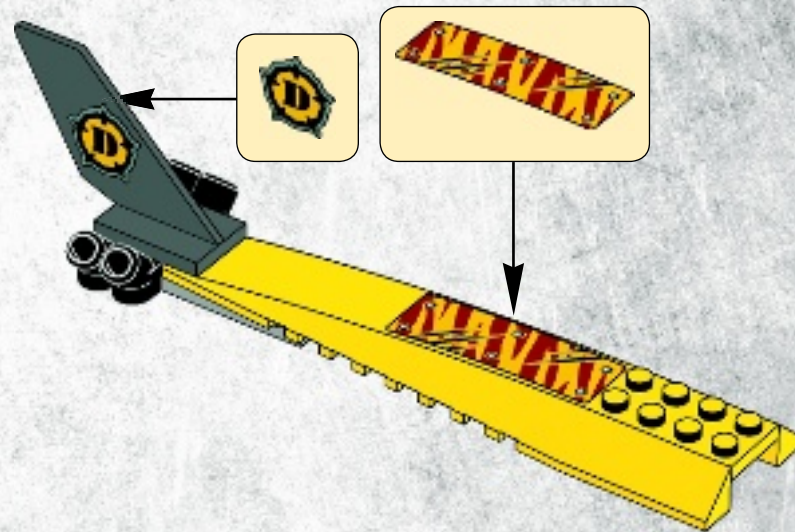



30

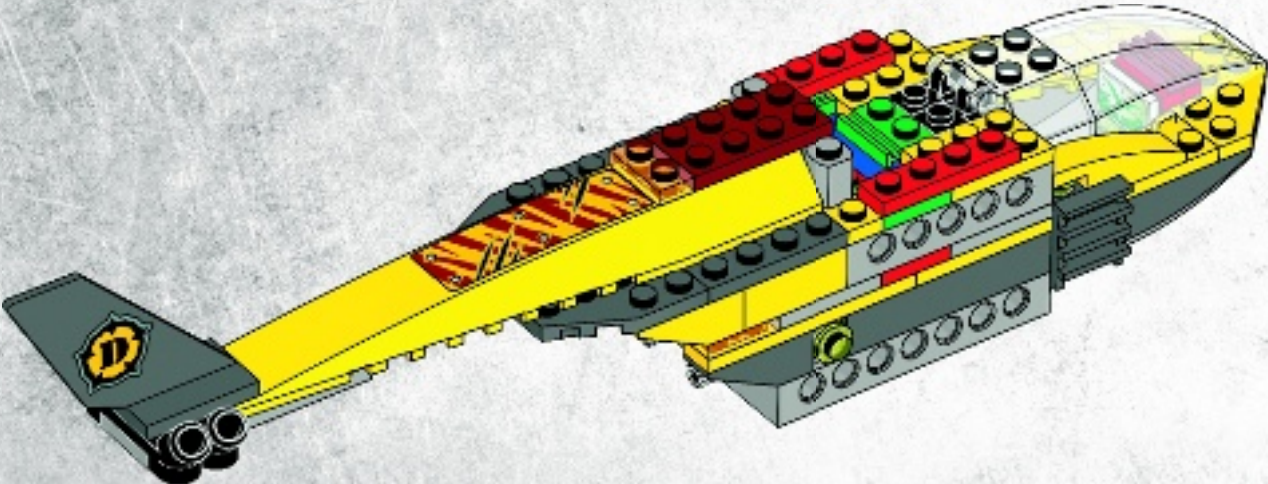



1x



2x

31

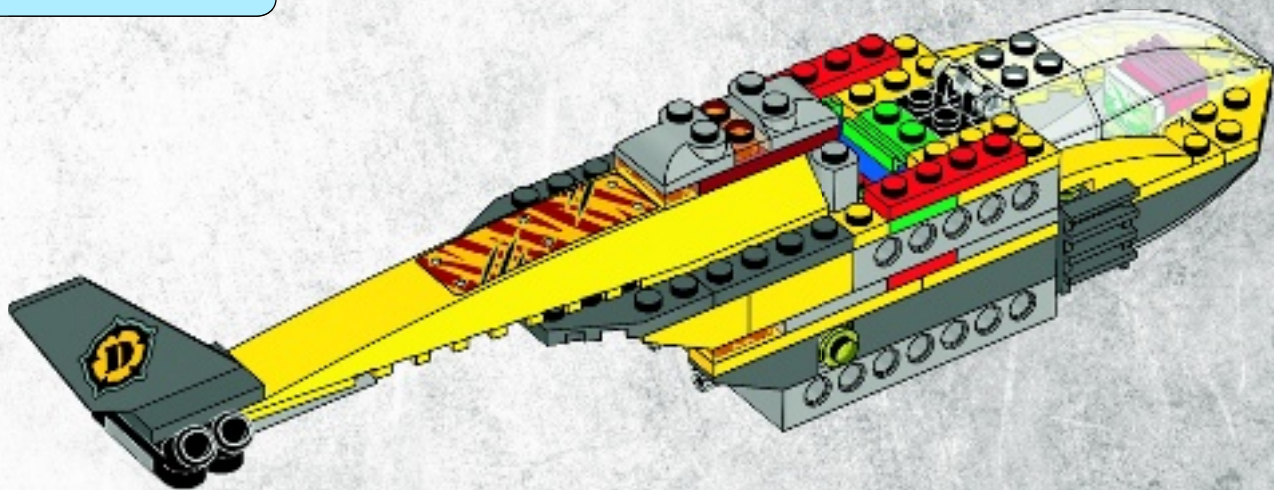

1x

32

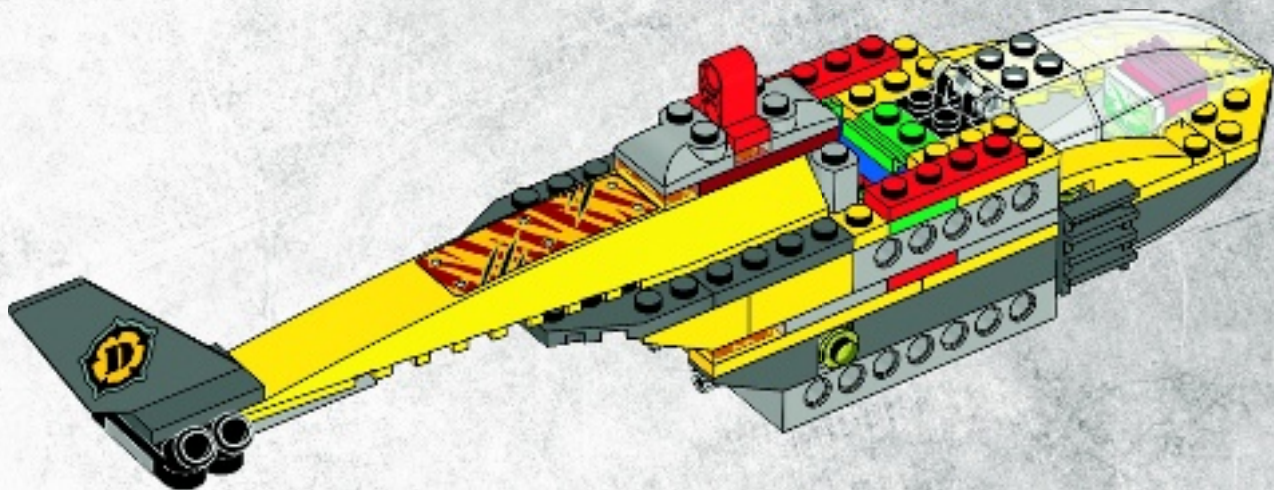



33

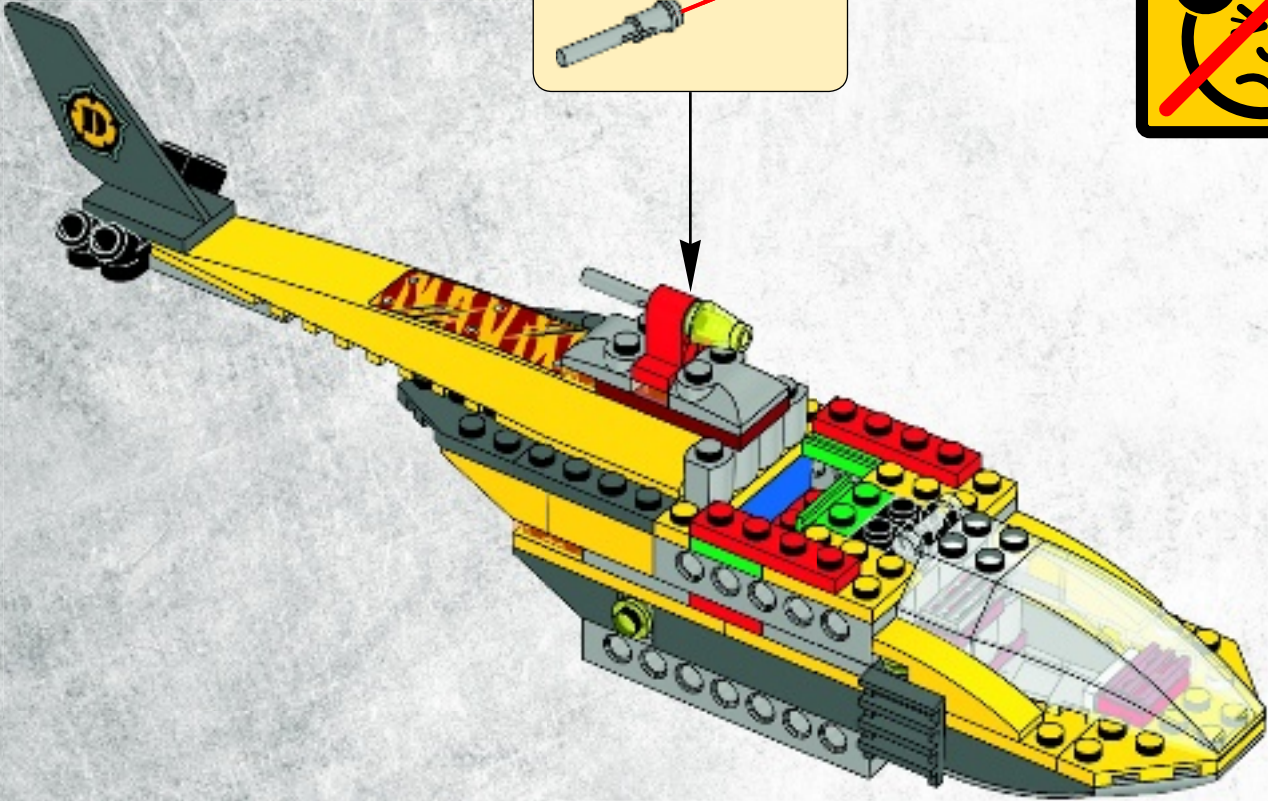
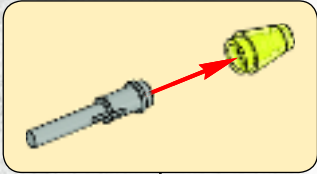
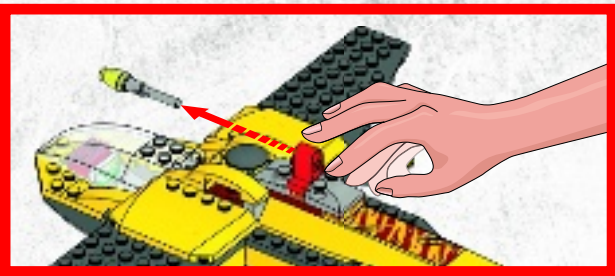



1x

34

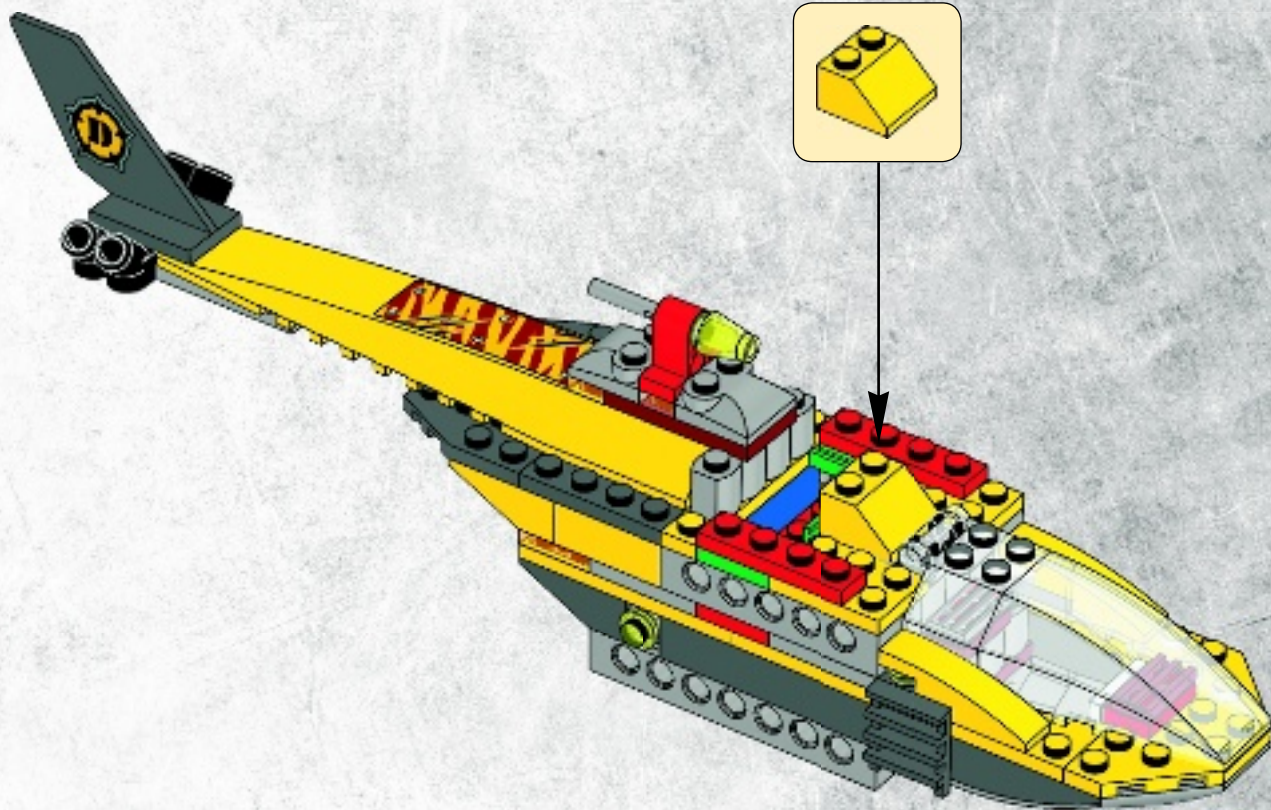



2x

35

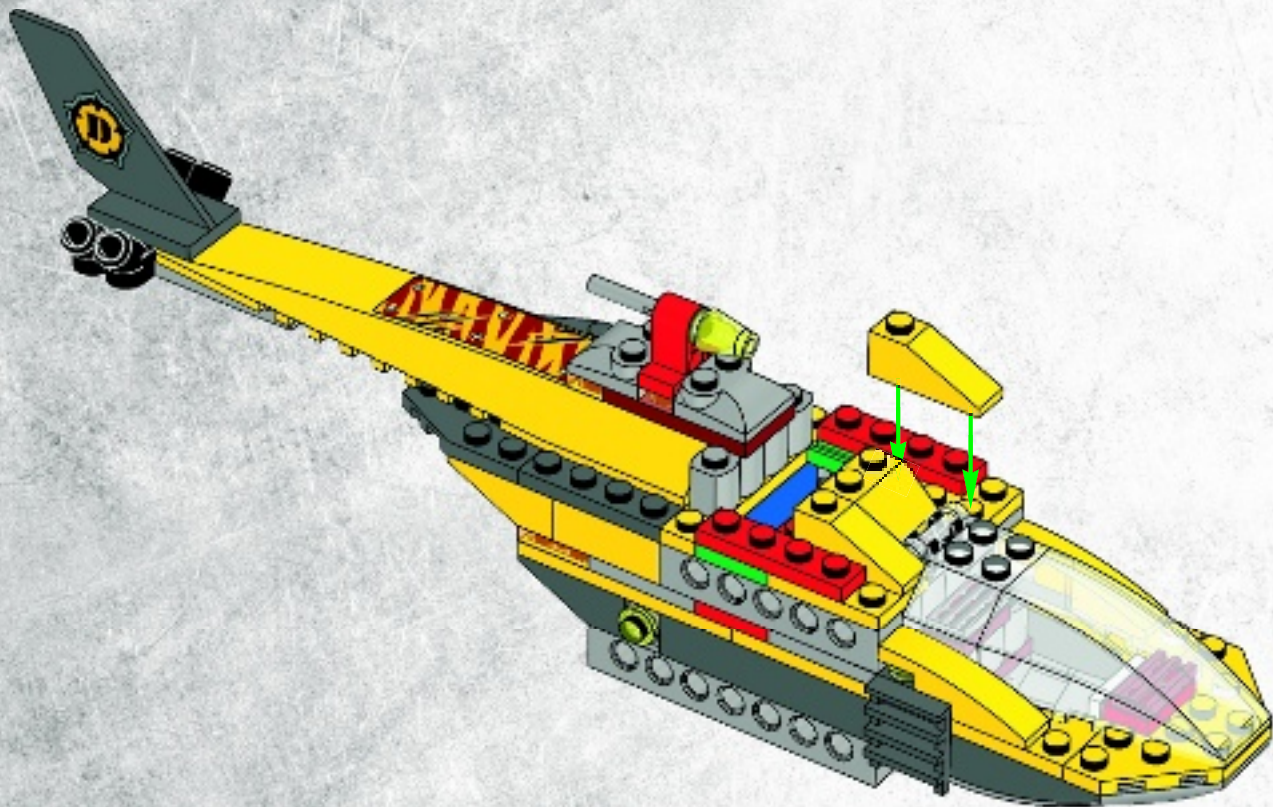

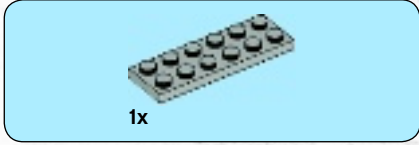
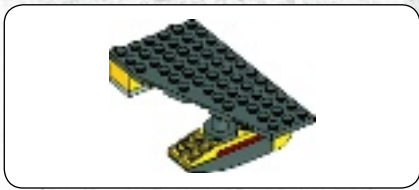

1x

1

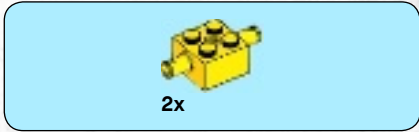
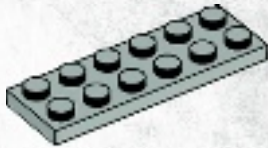

2x

2

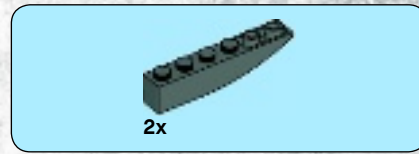
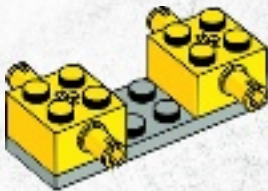

2x

3

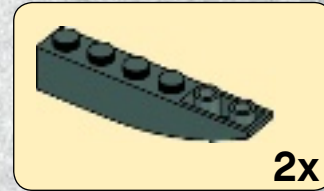

2x

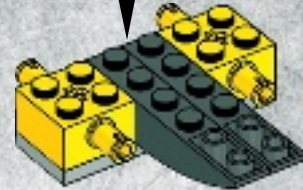

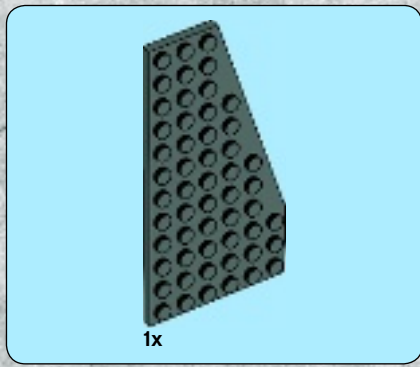

4

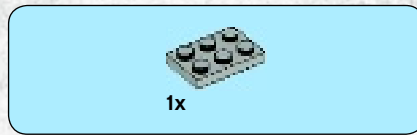
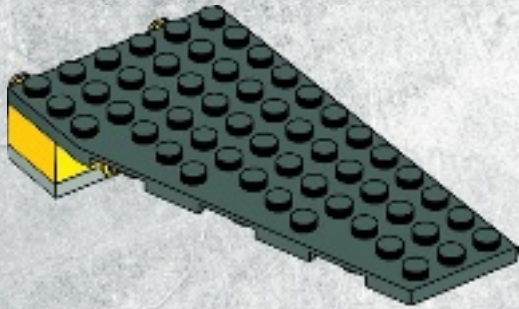

5

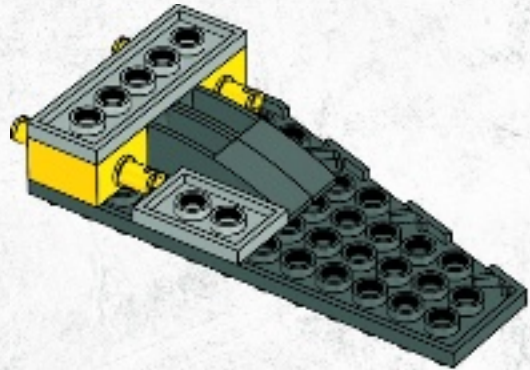
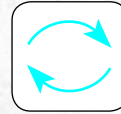

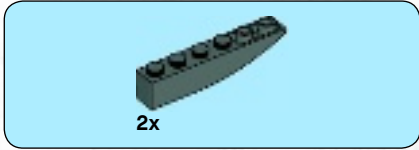

1

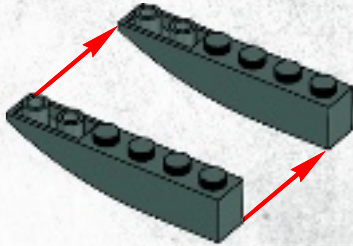

2

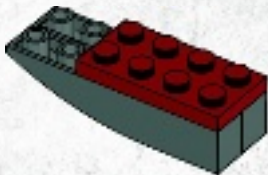

3

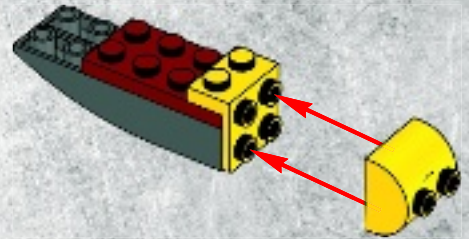

4

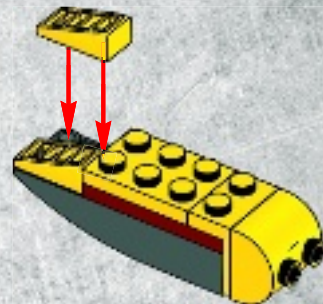



5

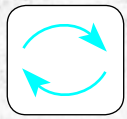

6



7

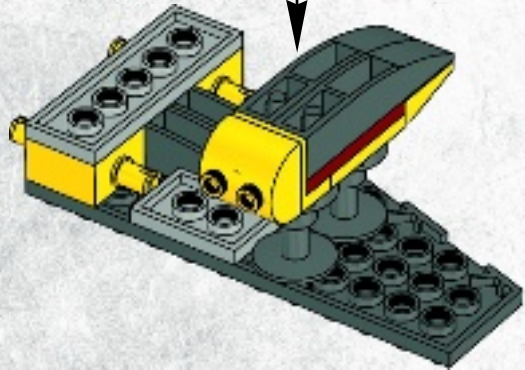

36

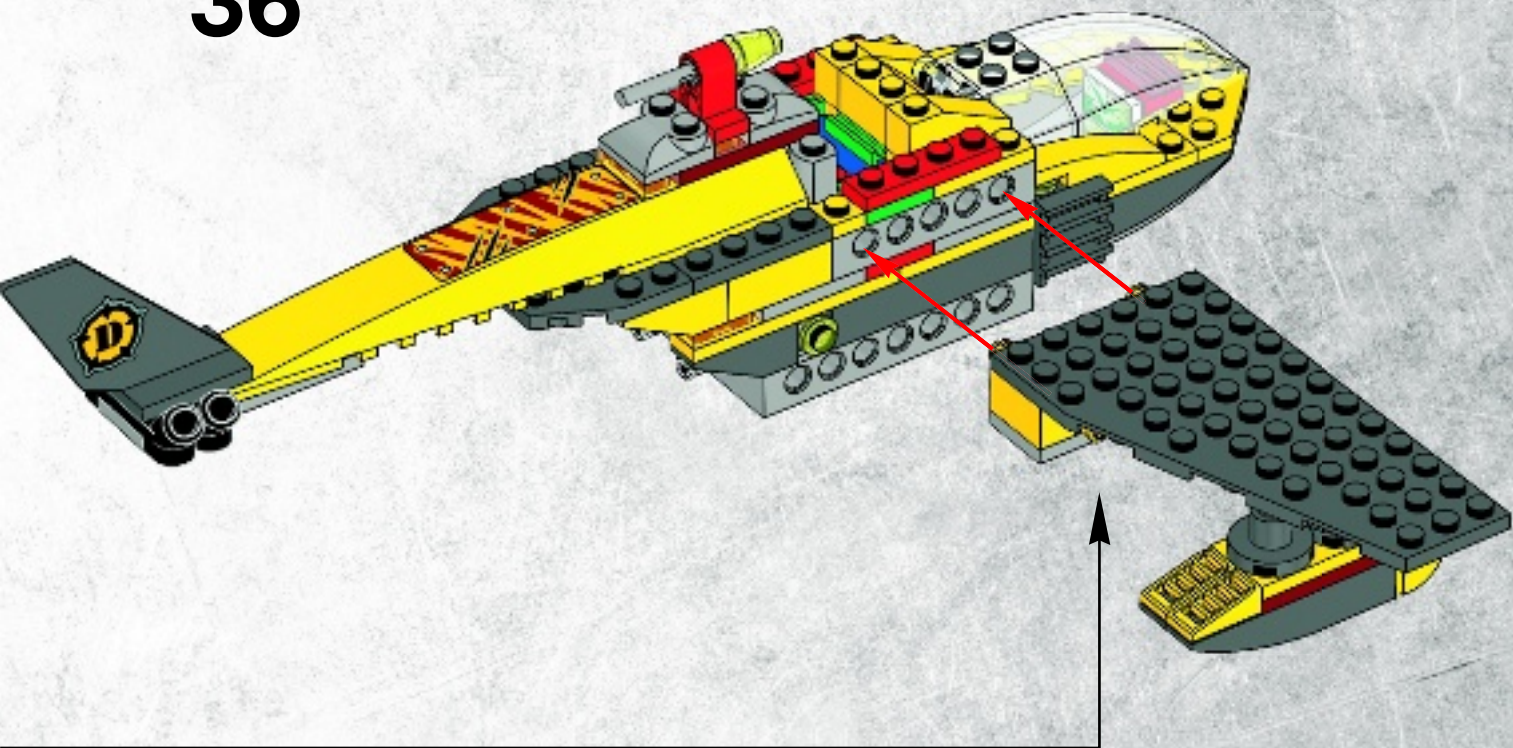

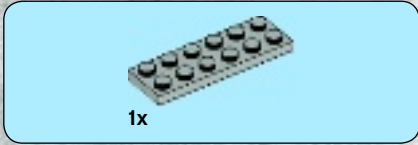

1

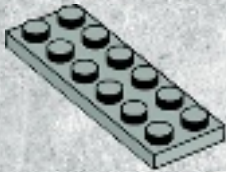

2

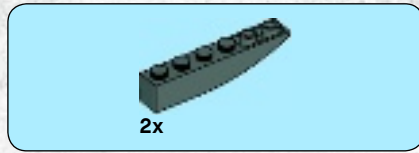
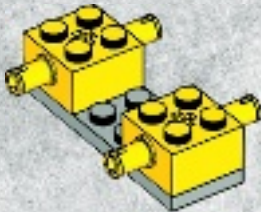

3

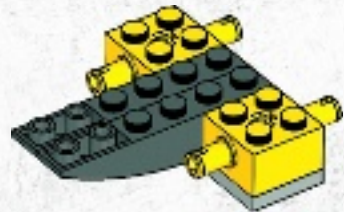

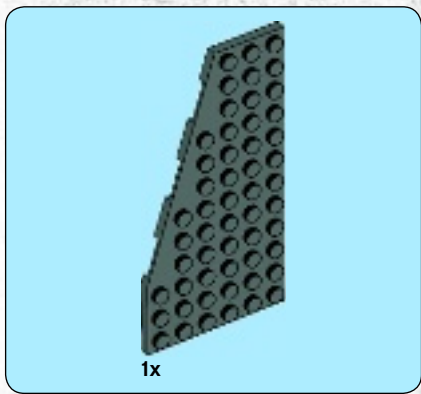

4

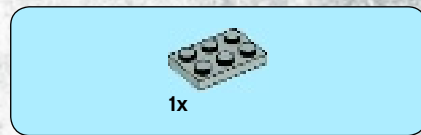
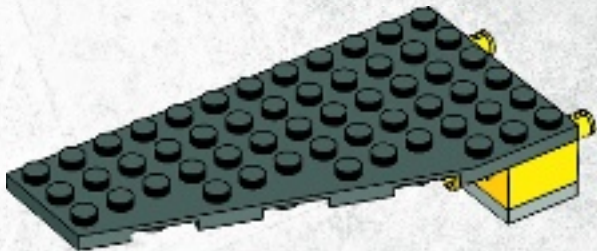

5

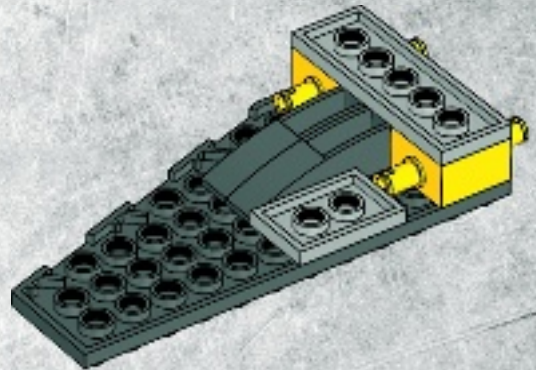
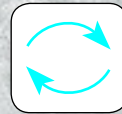



5



6

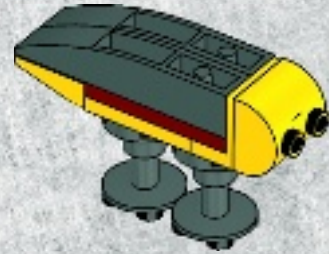
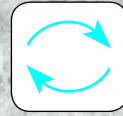

7

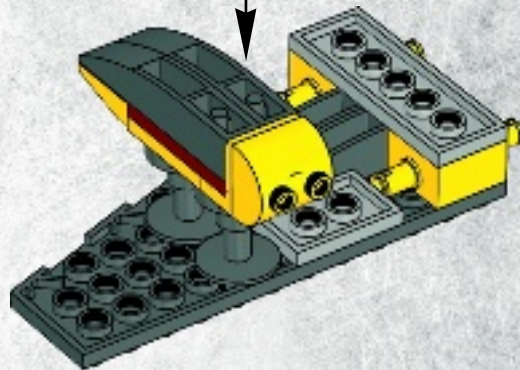

37

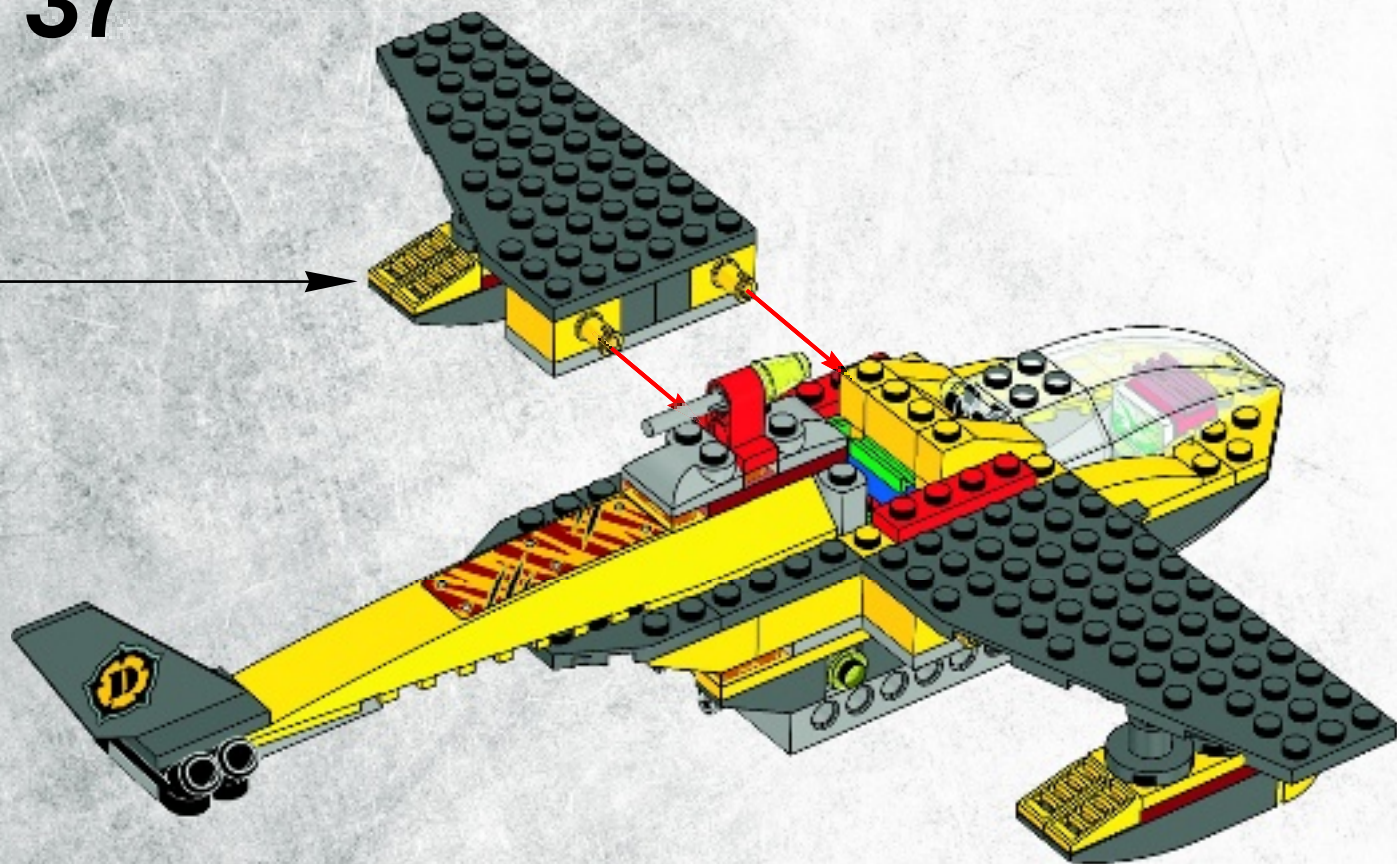



2x

38

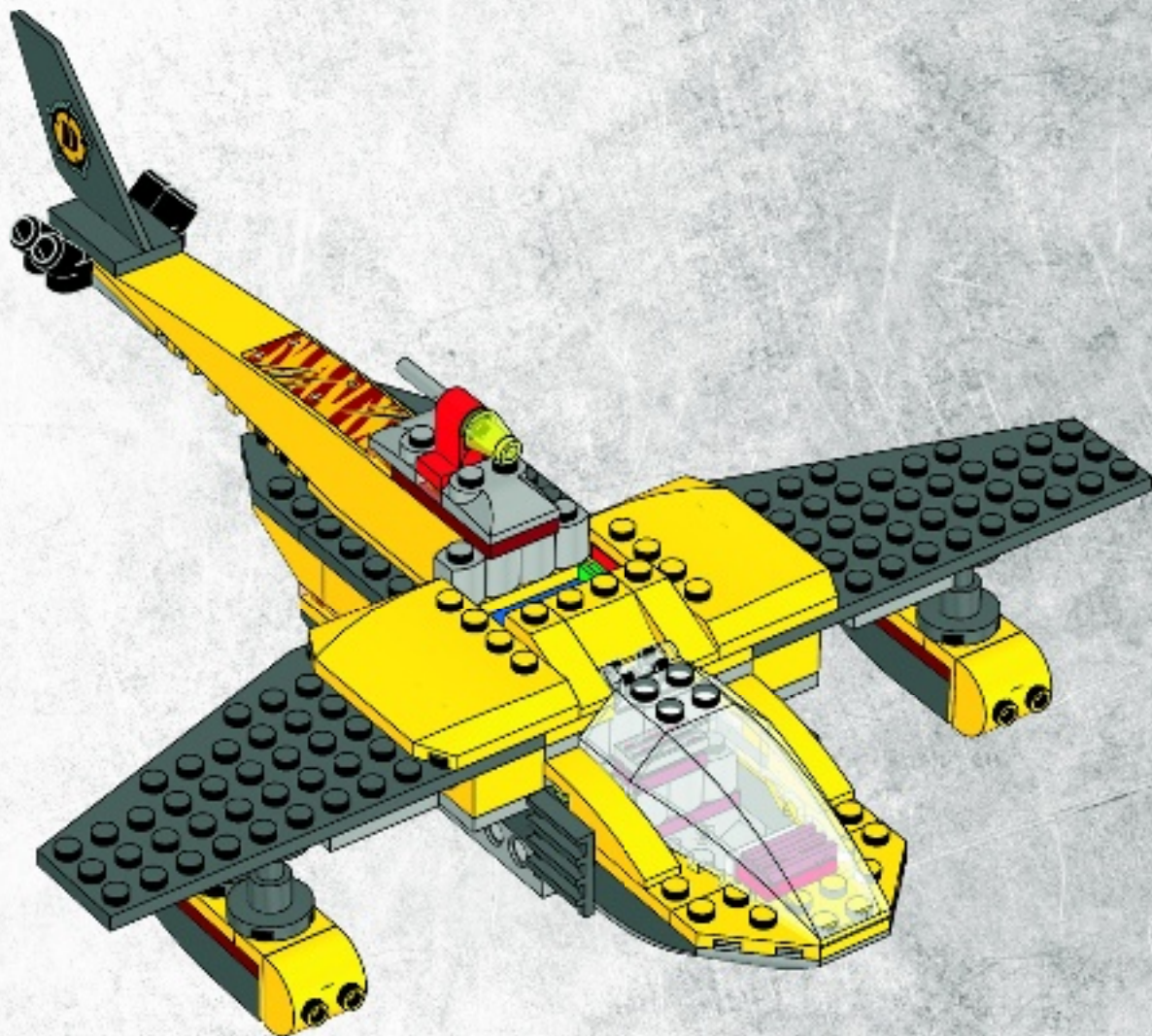

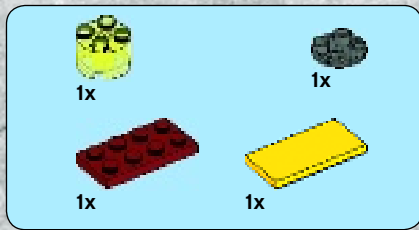

39

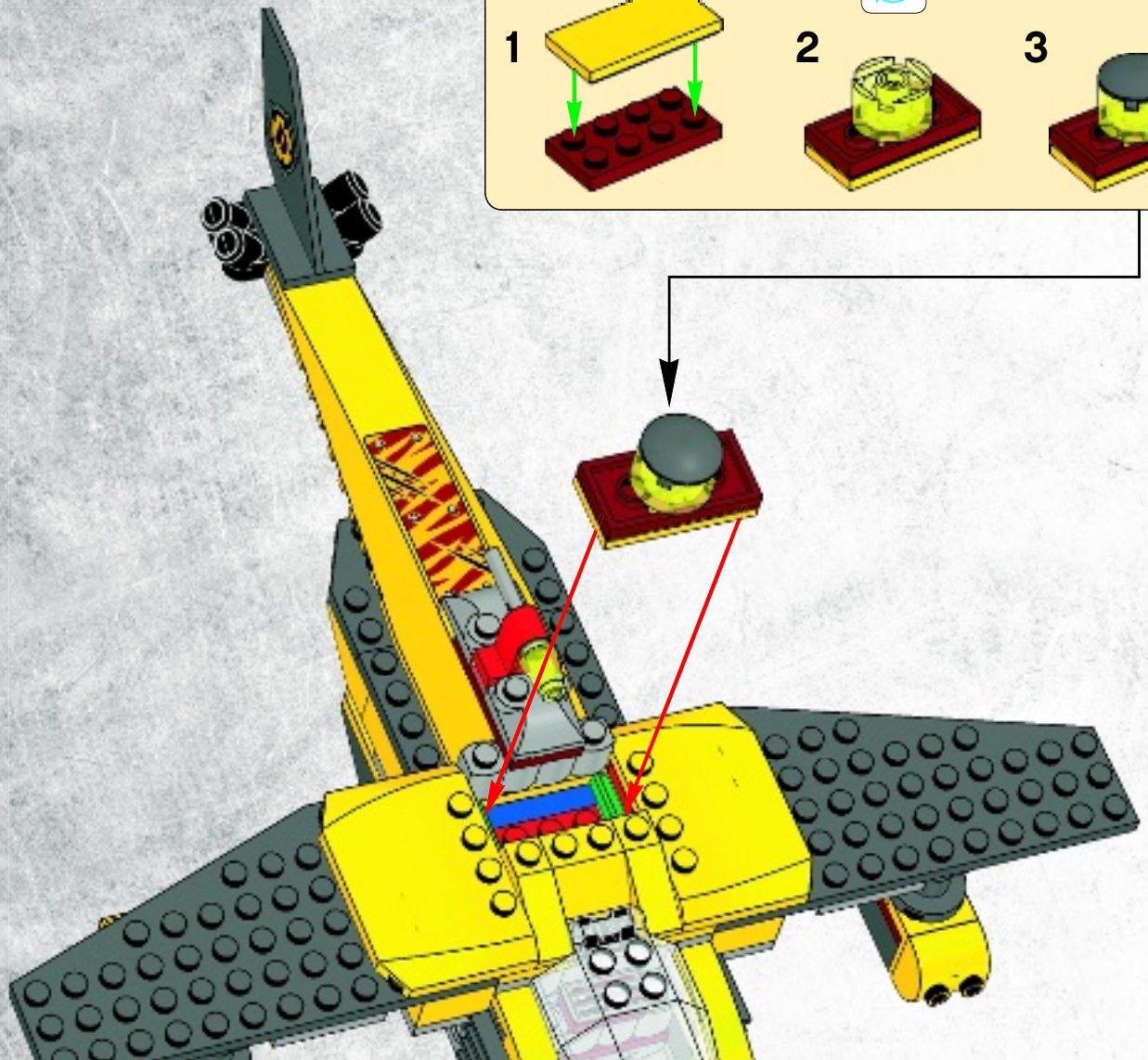



2x

40

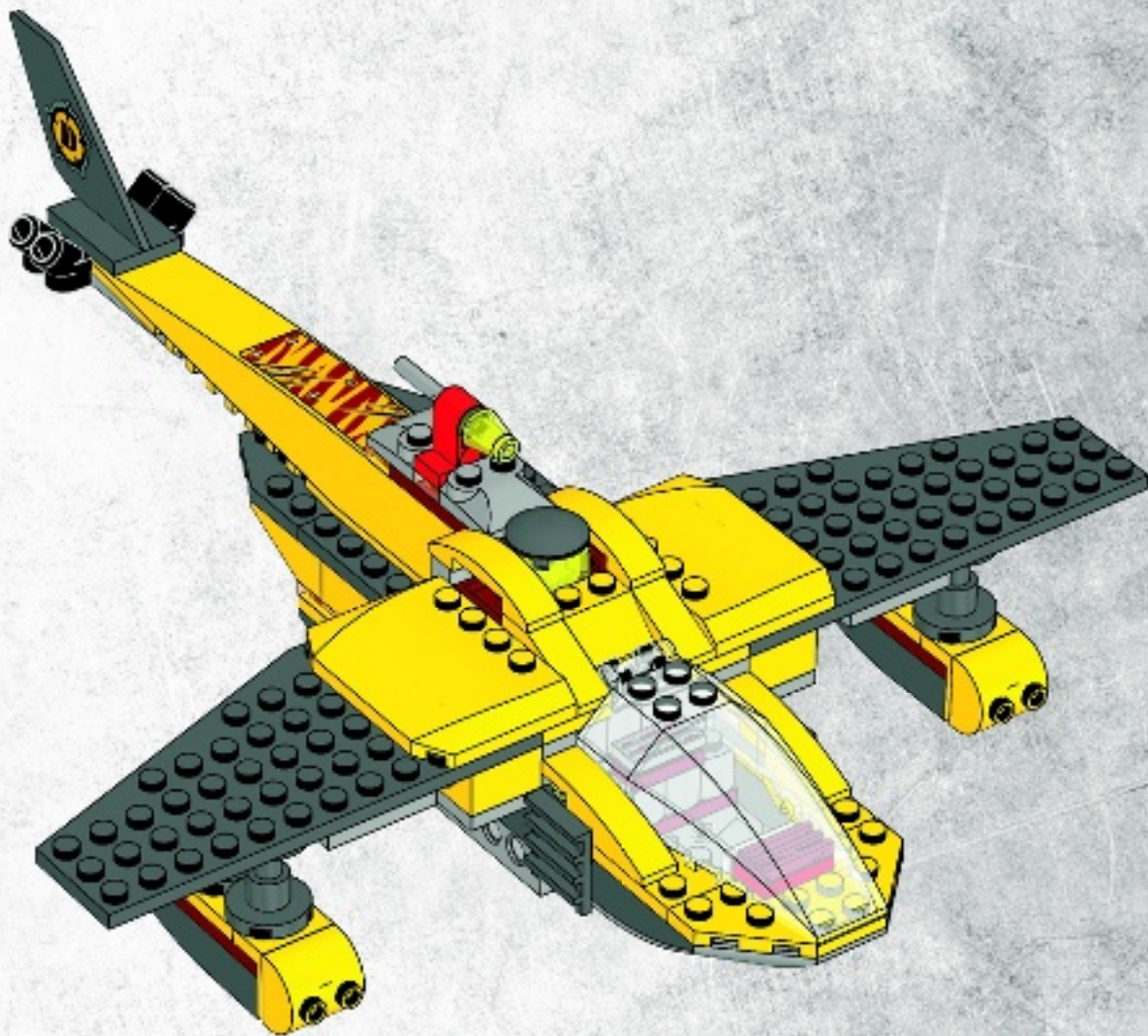



2x



3x

41

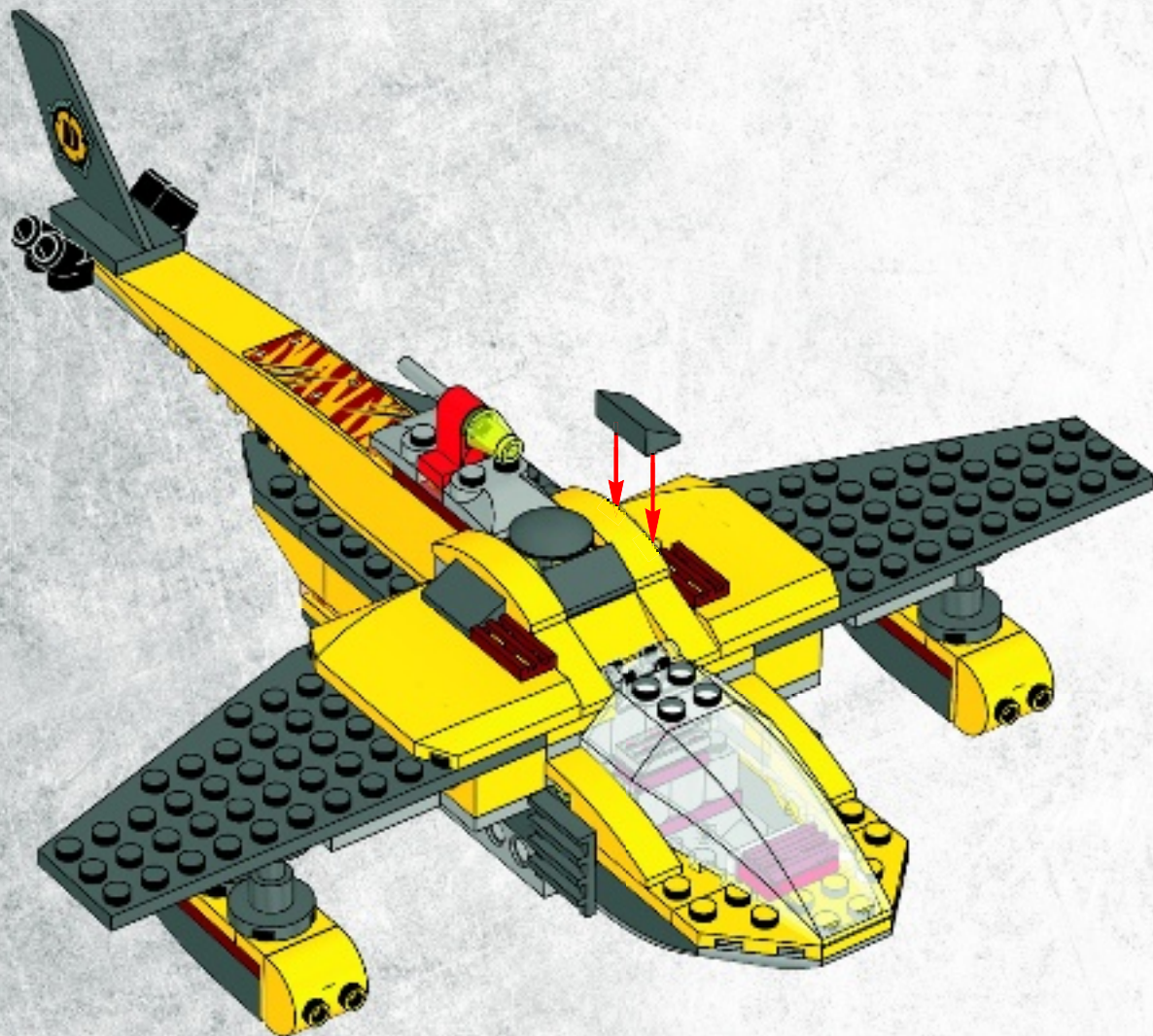

42

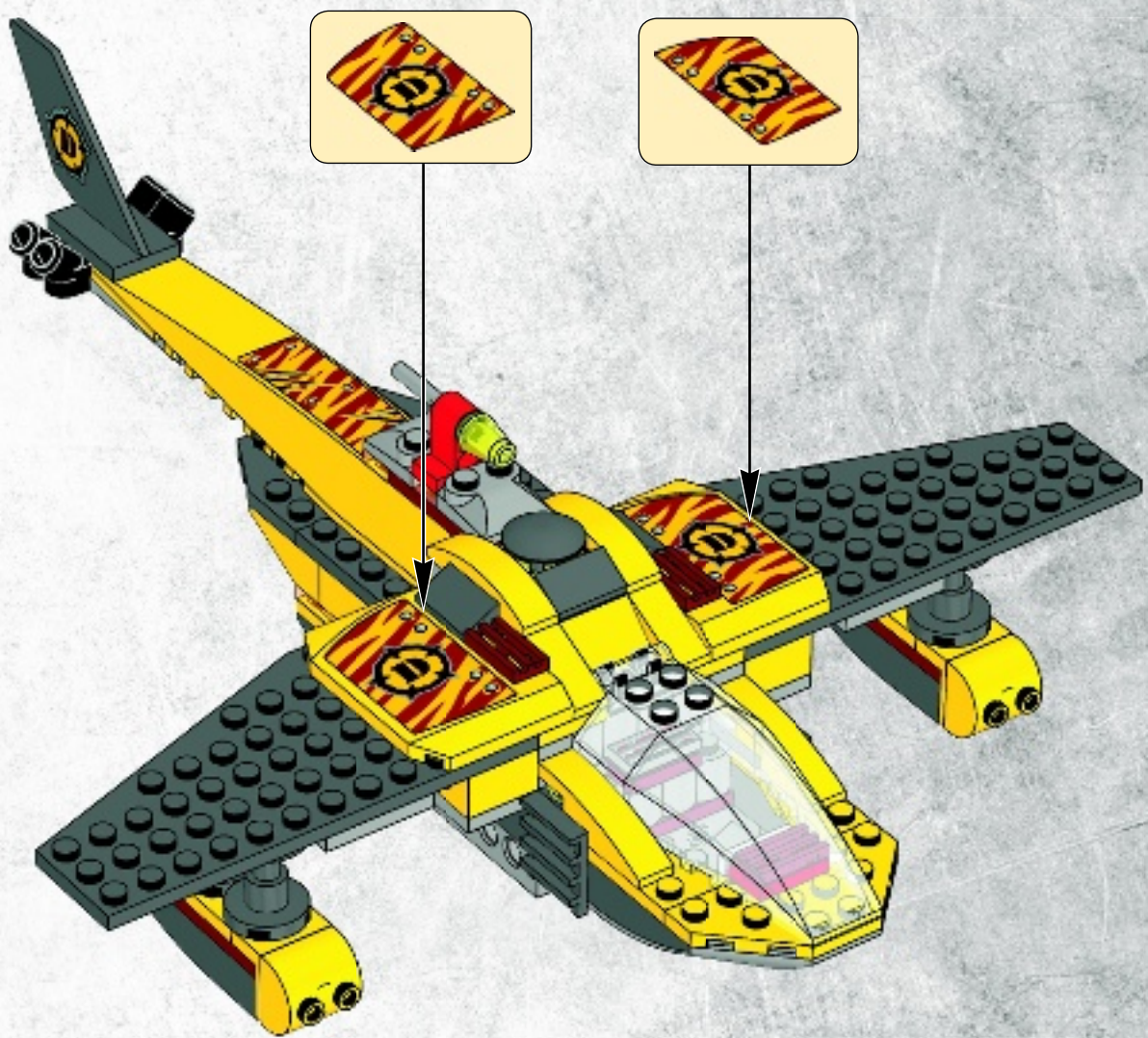



2x



2x



2x

43

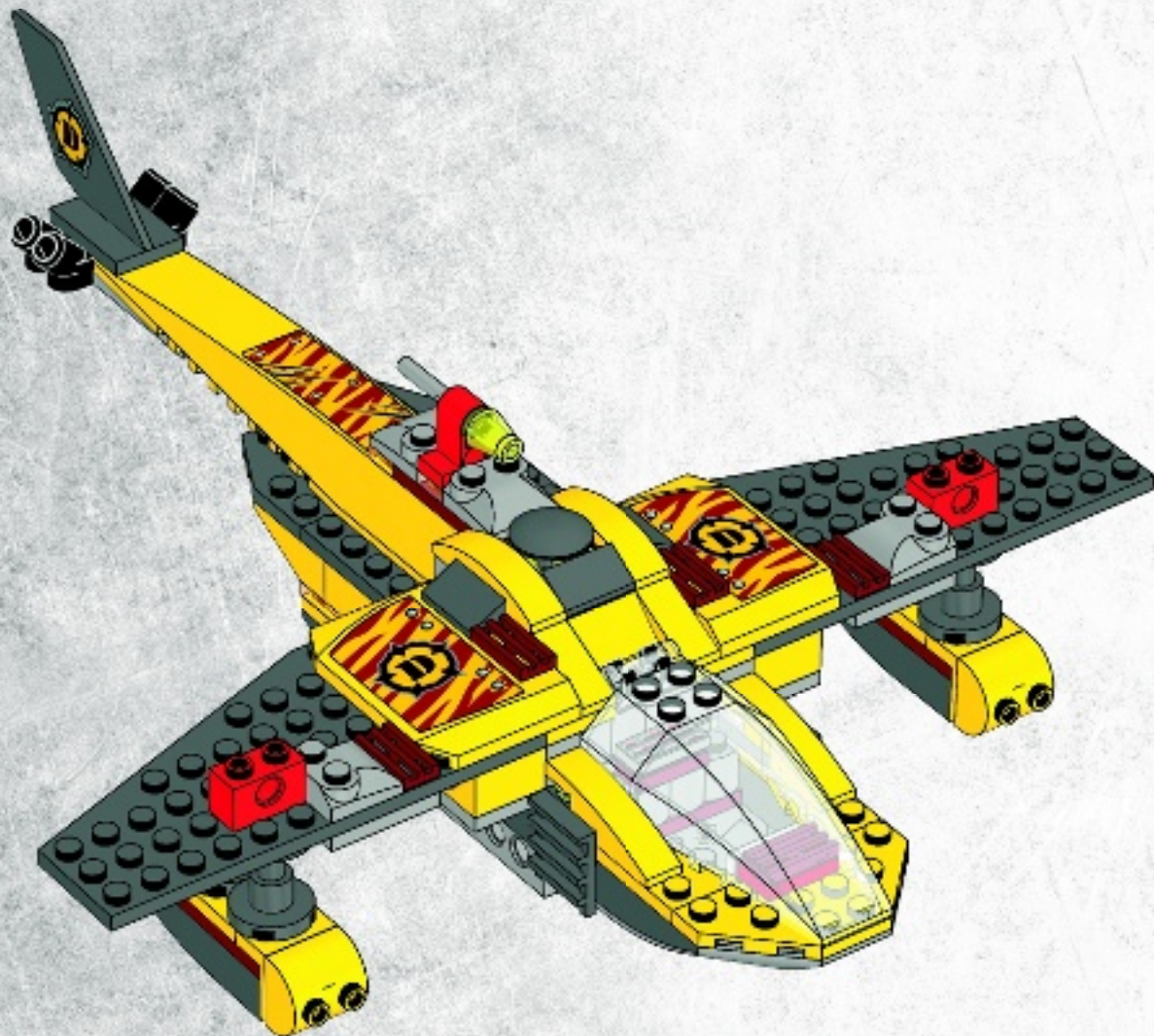



2x



2x

44

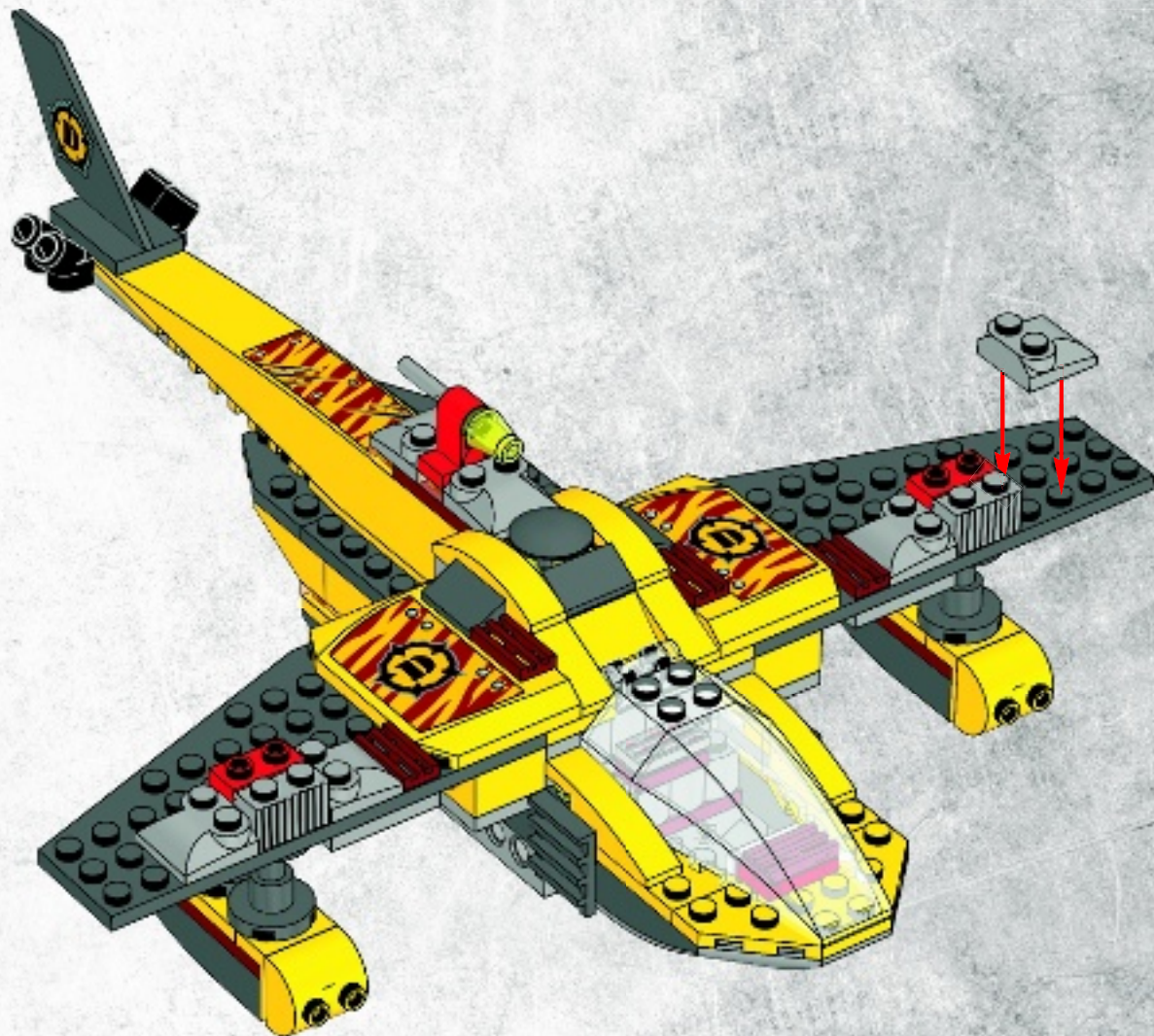



4x

45





2x

46





2x

47

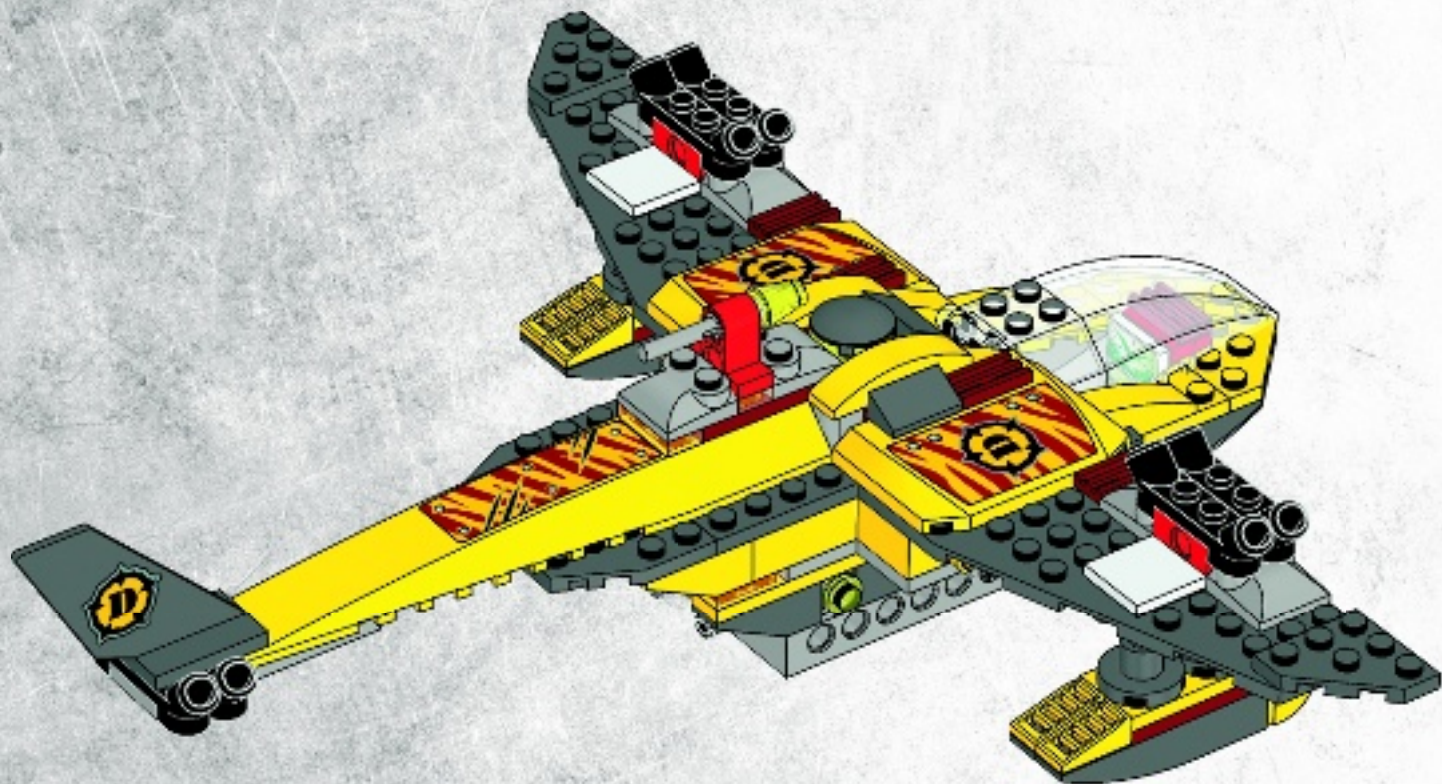



4x

48

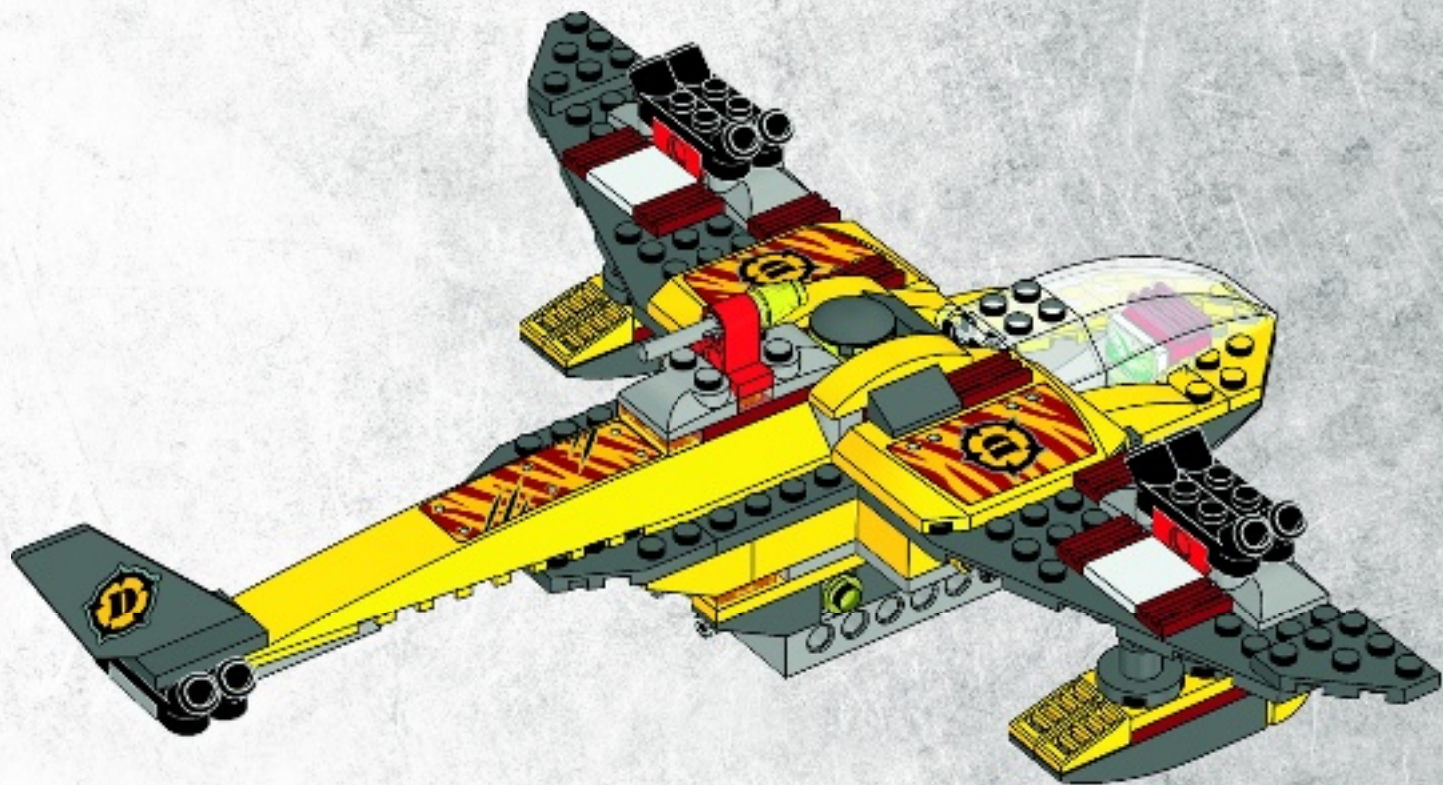

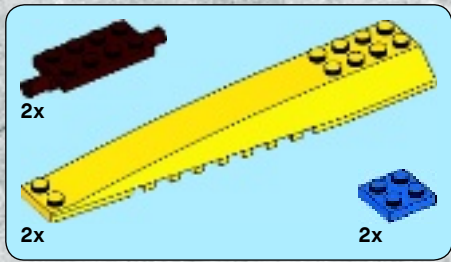

49

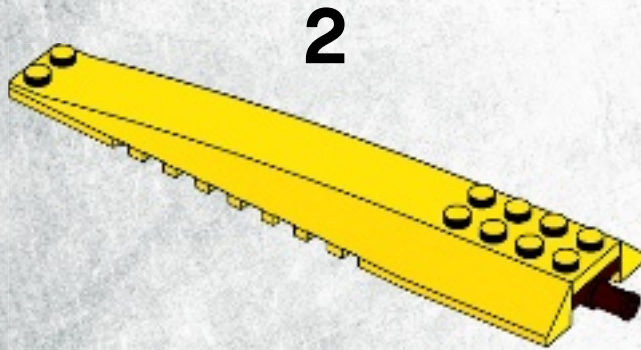
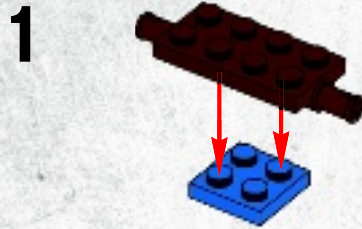

2x

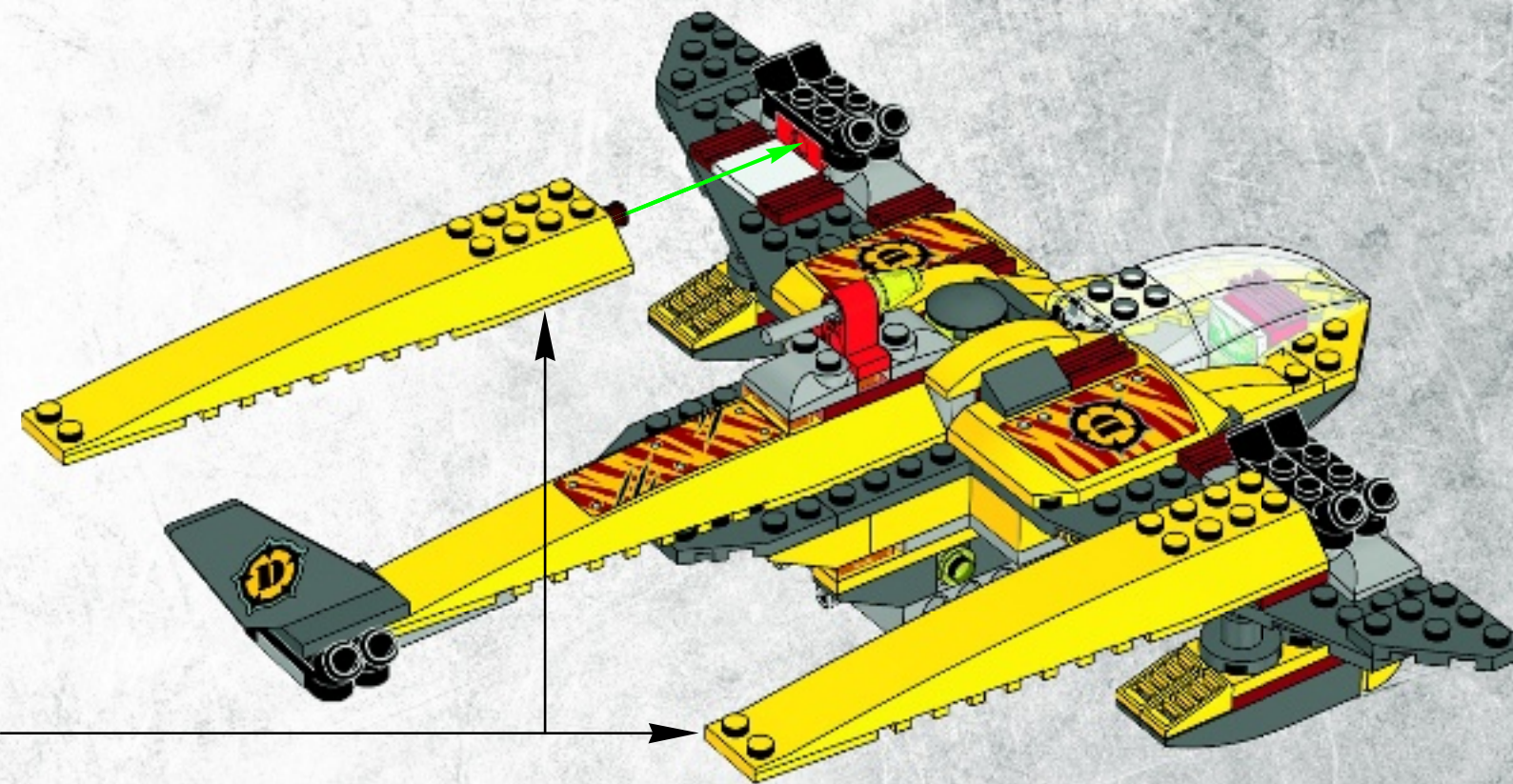



2x

50

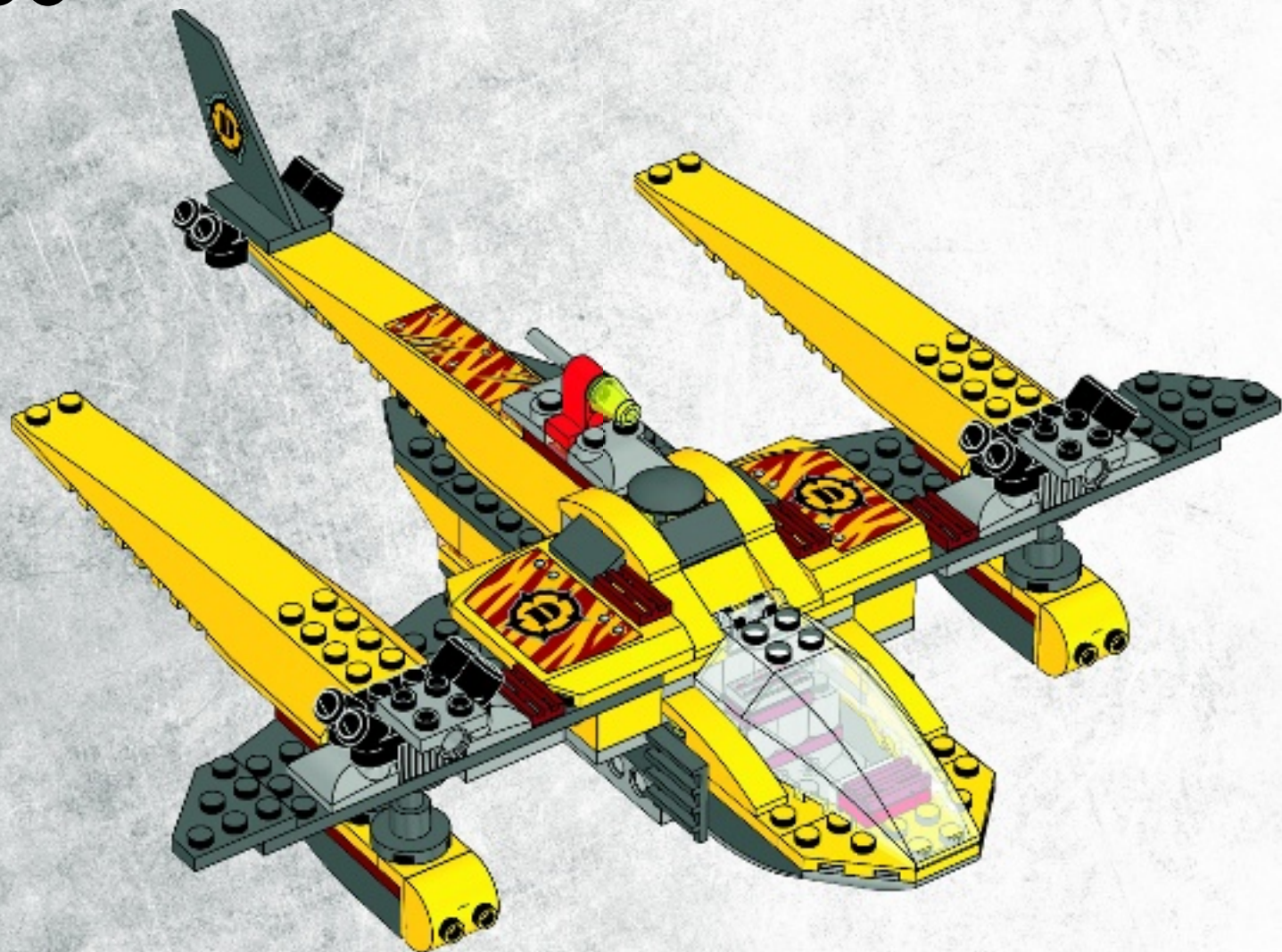



4x

51

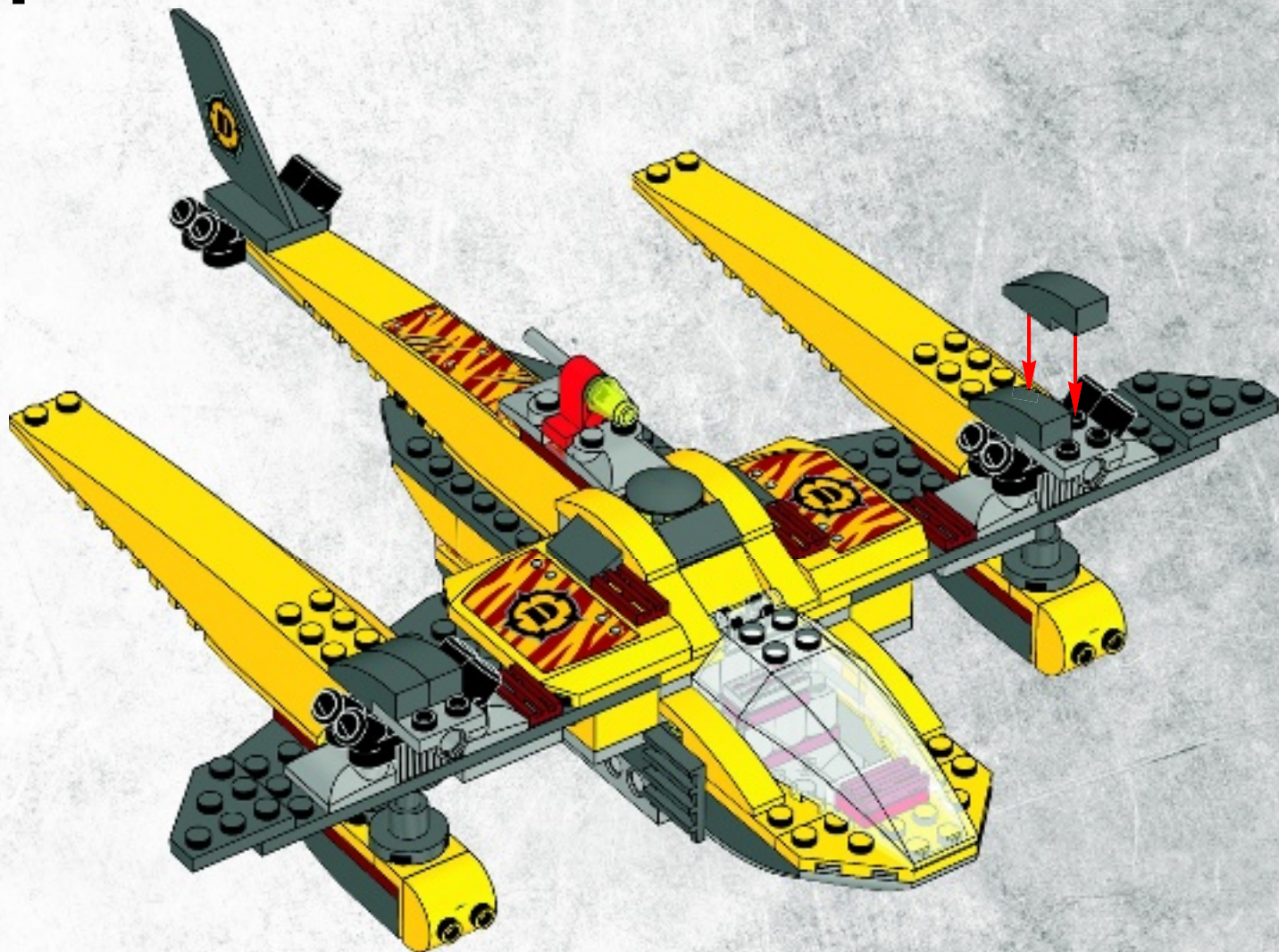



2x



2x

52

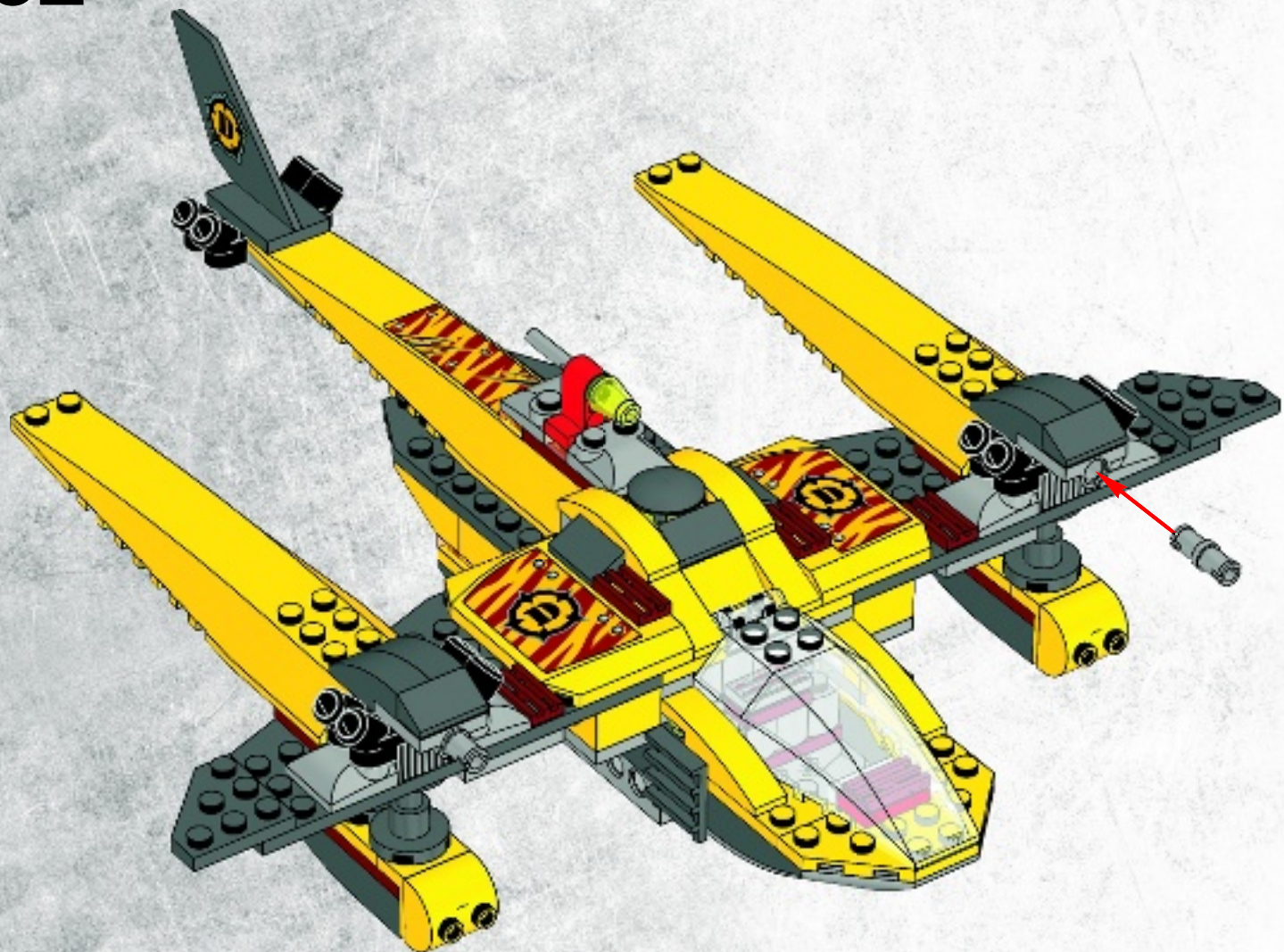

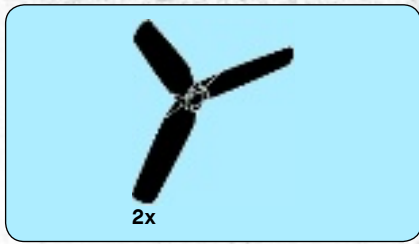

53

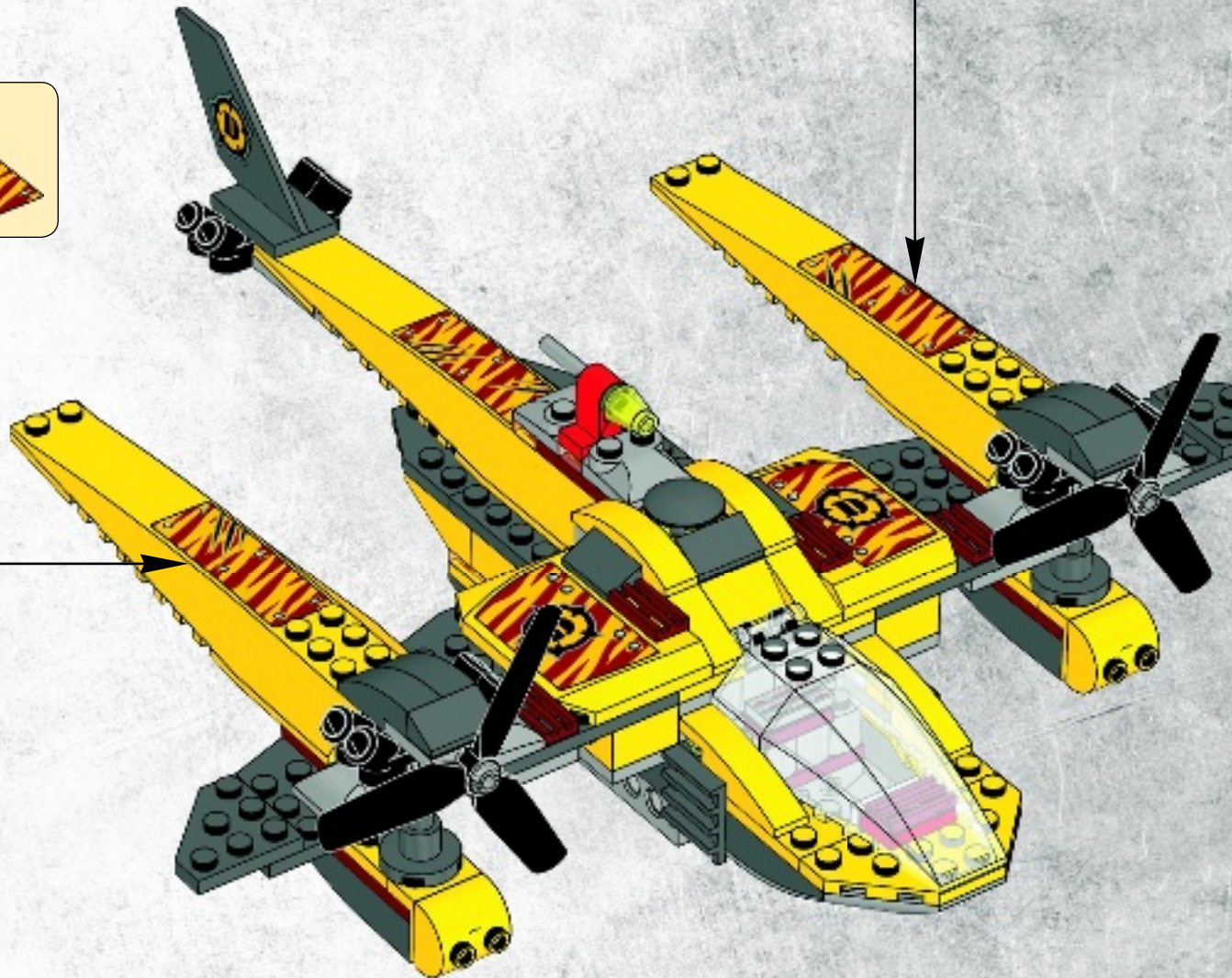

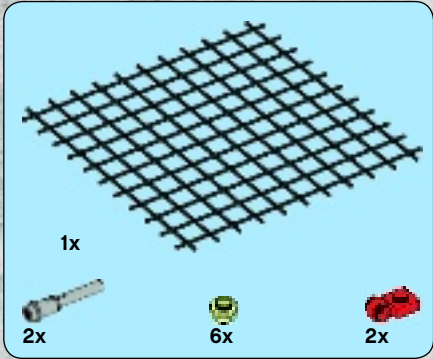
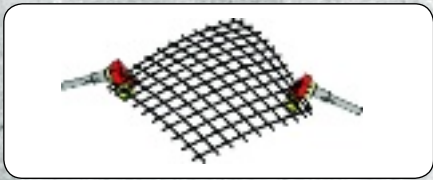

54

1

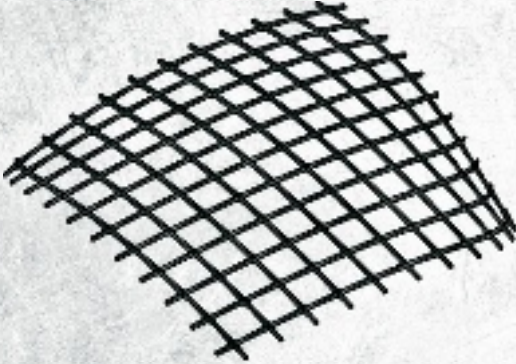

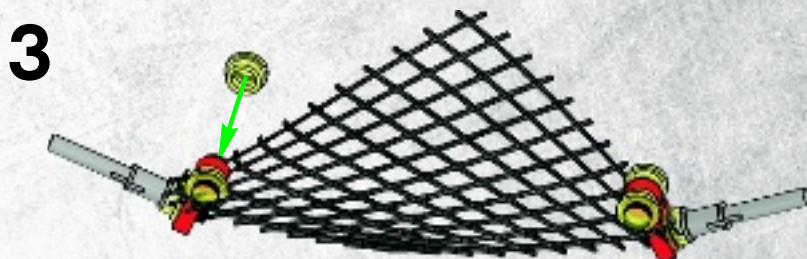
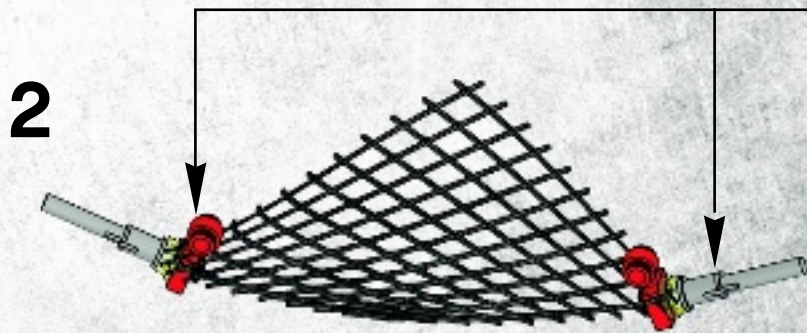
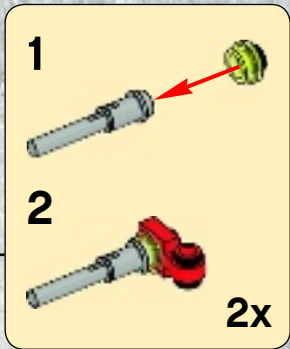

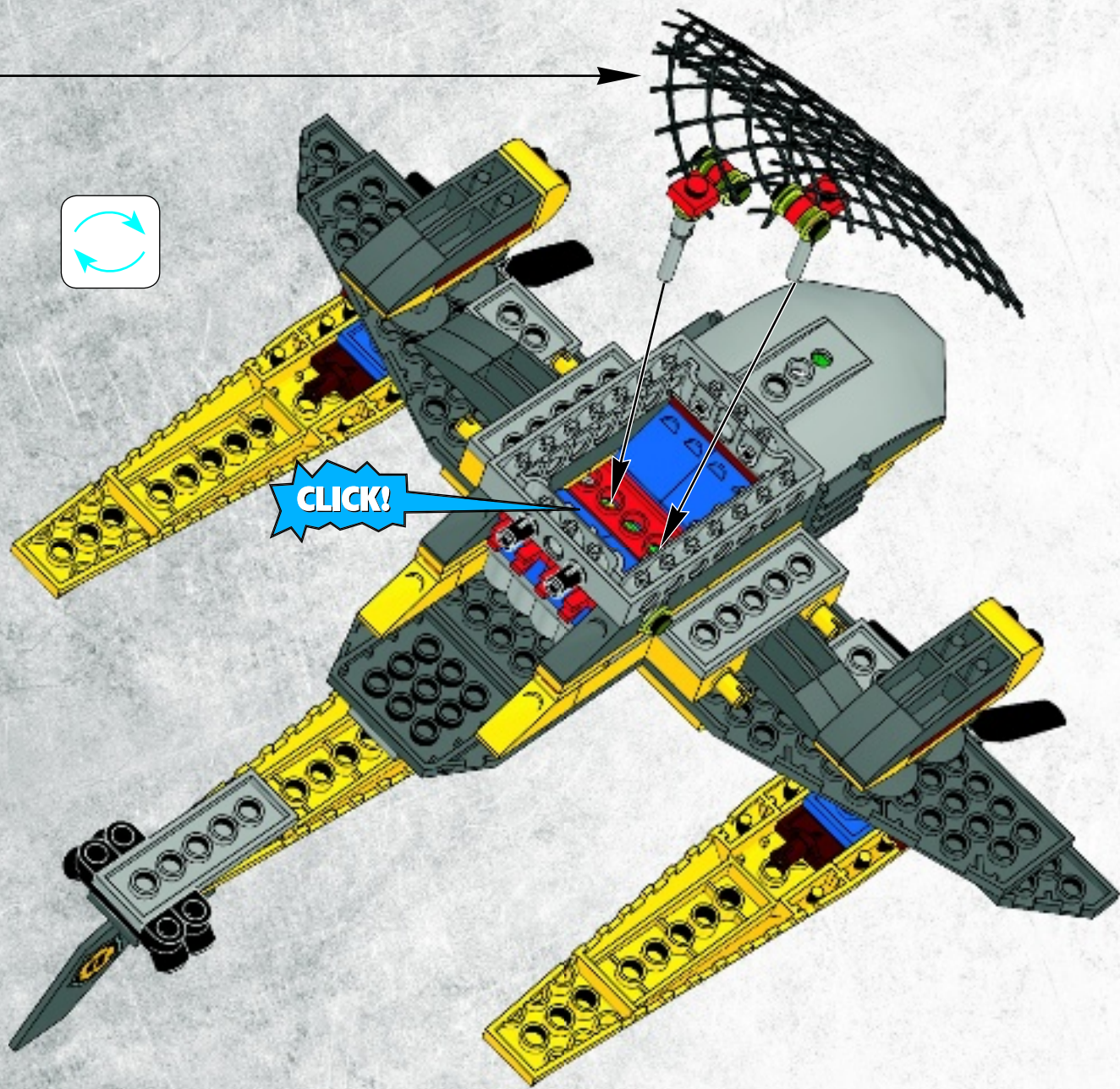

55

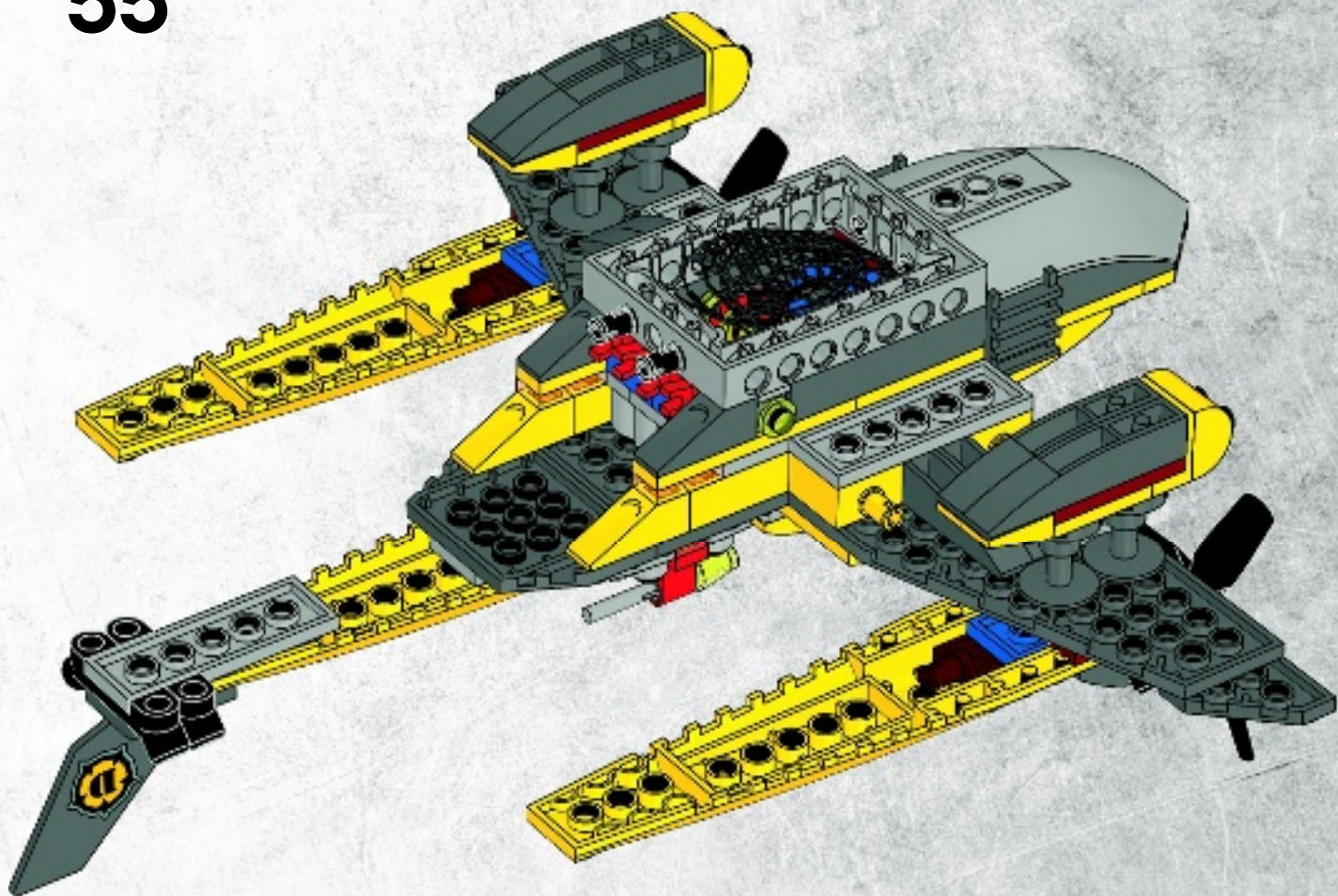

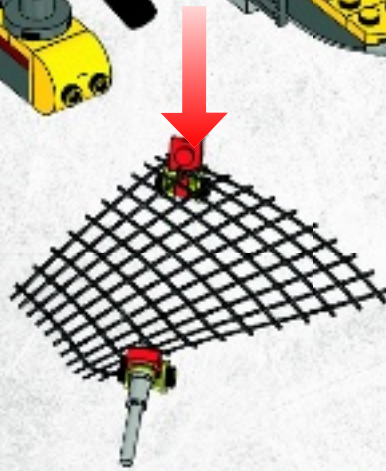
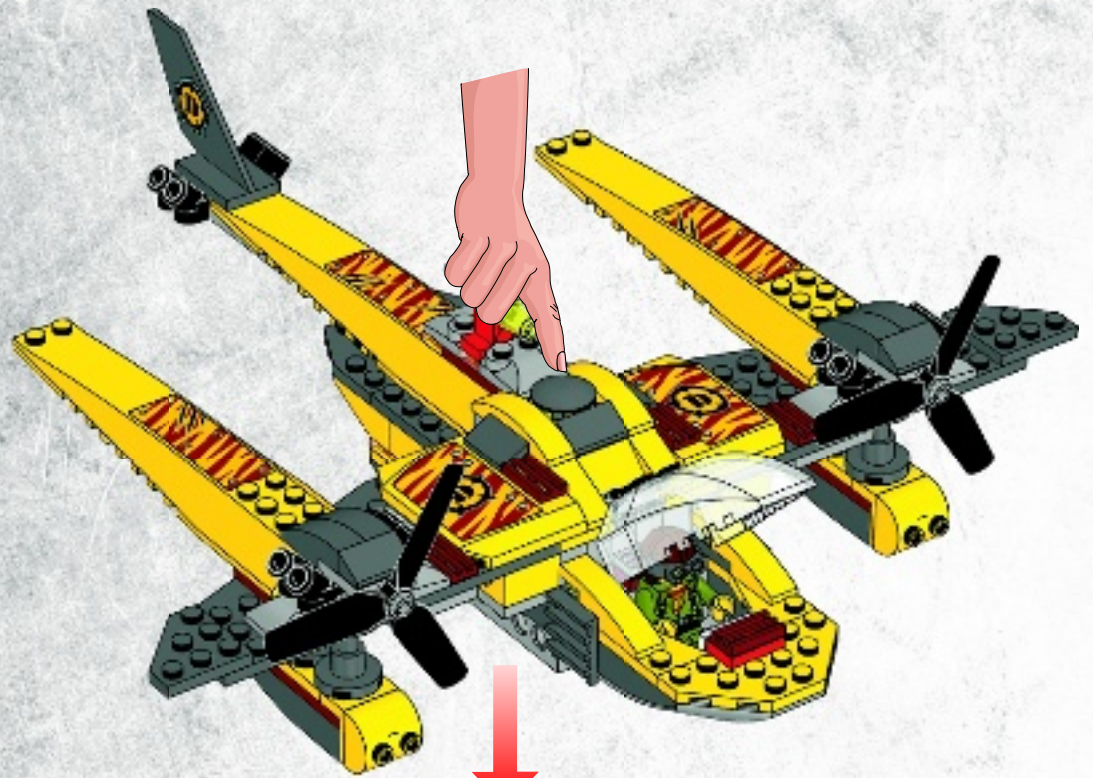



2x
306801



1x
4656556



2x
370021



2x
371021



2x
4632572



1x
4207715



1x
4277933



2x
4556153



1x
4582843



1x
4220515



2x
300123



4x
4509443



2x
302223



2x
362224



4x
4659478



1x
303924



2x
428724



2x
428624



2x
4187061



3x
4613151



2x
4522035



4x
302124



1x
4560181



5x
366624



3x
4656685



2x
4615642



1x
4501232



1x
4179095



1x
4179094



1x
241924



1x
4652361



1x
4654328



2x
4263142



4x
4540384



1x
4655887



3x
4272665



1x
4597715



7x
4539071



9x
4541506



1x
4561032



1x
4541496



4x
4211833



2x
4211466



1x
4550252



1x
4211848



4x
4211452



7x
4211396



2x
4211359



7x
4494475



1x
4212363



2x
4211383



2x
4211476



3x
4520320



2x
4211807



6x
4280341

Customer Service
Kundenservice
Service Consommateurs
Servicio Al Consumidor

www.lego.com/service or dial



: 00800 5346 5555

: 1-800-422-5346



10x
4210779



1x
4500562



1x
4636417



1x
4211115



1x
4521572



1x
4271542



1x
4271543



2x
4211100



5x
4567887



2x
4211068



1x
4211076



4x
4246896



1x
4210645



1x
4261908



2x
4598769



2x
4603504



1x
4210660



1x
4278274



4x
4211110



4x
4211110



2x
4210897



1x
4654583



1x
4659729



1x
4659545



1x
4654423



1x
4656496



1x
4656491



1x
4656477



1x
4656725



1x
4656479



1x
4656726



1x
4567334



1x
611649



10x
3005749



1x
4656478



1x
4507049



2x
4270882



4x
4121715



2x
4598528



1x
4223247



6x
4516196



2x
4142731

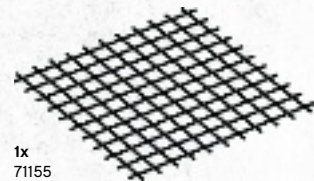

1x
71155



www.LEGOclub.com



LEGO® Club Email

LEGO club™

FREE! GRATIS! GRATUIT!



LEGO® Club Magazine

SIGN UP ONLINE!

www.LEGOclub.com



00800 5346 5555*



1-866-534-6258 • 1-877-518-5346

US & Canada only

Canada seulement

* Freephone. Mobile charges may apply.
* Numéro sans frais. Des frais peuvent s'appliquer avec les téléphones cellulaires.
* Gebührenfrei, Kosten für Anrufe aus Mobilfunknetzen können abweichen.
* Gratis telefonnummer vanaf vaste lijn.
* Det är ett gratis nummer, när du ringer fra fasttelefon.
* Det är gratis, när du ringer från en fast telefon.
* Numéro sans frais. Des frais peuvent s'appliquer avec les téléphones portables.



WIN!

Go to www.LEGOsurvey.com/product to fill out a survey for a chance to win a cool LEGO® Product. No purchase necessary. Open to all residents where not prohibited.

 www.LEGO.com



www.LEGOsurvey.com/product

GEWINNE! WIN!

Nimm an der Umfrage auf www.LEGOsurvey.com/product teil und hab die Chance ein cooles LEGO® Produkt zu gewinnen!
Die Teilnahme am Gewinnspiel führt zu keinerlei Kaufverpflichtungen. Teilnahme in allen nicht ausgeschlossenen Ländern möglich.

Ga naar www.LEGOsurvey.com/product, vul een enquêteformulier in en maak kans op een cool LEGO® product.
Geen aankoopverplichting. Iedereen mag deelnemen, uitgezonderd ingezetenden van landen waar een enquêteverbod geldt.

GAGNE! 当てよう!

Visite www.LEGOsurvey.com/product pour répondre à un questionnaire et avoir une chance de gagner un produit LEGO® très cool!
Aucune obligation d'achat. Ouvert à tous les résidents des pays autorisés.

www.LEGOsurvey.com/product にアクセスして、アンケートにご記入ください。当選者にはレゴ®製品を差し上げます。
お買い上げの必要はありません。
禁止されていない限り、すべての皆様にご利用いただけます。